

INSTRUCTIONS FOR USE

and installation

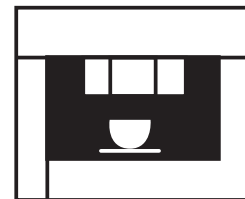

EN

CKV6750.0S

Küppersbusch

Lesen Sie unbedingt die Gebrauchsanleitung und den Montageplan vor Aufstellung, Installation sowie Inbetriebnahme.

Please read the users and installation instructions carefully before installation of the appliance and before starting to use it.

Service und Kundendienst

Telefon: 0209 – 401 631

Email: kundendienst@kueppersbusch.de

Küppersbusch
FÜR KÜCHEN MIT STIL

CONTENTS

INTRODUCTION	3	Changing coffee temperature	9
Symbols used in these instructions	3	Setting water hardness	10
Letters in brackets.....	3	Programming coffee	10
Troubleshooting and repairs	3	Programming cappuccino	10
		Programming water.....	10
SAFETY	3	Descaling	10
Fundamental safety warnings.....	3	Resetting default values (reset)	10
Designated use	3	Statistics	10
Instructions	3	Buzzer	10
		Adjusting contrast.....	10
DESCRIPTION	4	TURNING THE APPLIANCE OFF	10
Description of the appliance	4	TECHNICAL SPECIFICATION	10
Description of the control panel.....	4	DISPLAYED MESSAGES	11
Description of milk container and accessories	4	TROUBLESHOOTING	12
PRELIMINARY CHECKS	4	RECIPES	13
Controls after transport	4		
Installing the appliance	4		
Connecting the appliance	4		
BUILT-IN INSTALLATION	5		
USING THE APPLIANCE FOR THE FIRST TIME	6		
TURNING ON AND HEATING UP	6		
MAKING COFFEE USING COFFEE BEANS	6		
CHANGING THE QUANTITY OF COFFEE IN THE CUP	6		
ADJUSTING THE COFFEE MILL	7		
MAKING ESPRESSO COFFEE WITH PRE-GROUND COFFEE (INSTEAD OF BEANS)	7		
DELIVERING HOT WATER	7		
CHANGING THE QUANTITY OF HOT WATER	7		
MAKING CAPPUCCINO	7		
CHANGING THE QUANTITY OF MILK AND COFFEE FOR CAPPUCCINO .	7		
Changing the quantity of milk	7		
Changing the quantity of coffee.....	8		
CLEANING	8		
Cleaning the coffee maker	8		
Cleaning the waste coffee container	8		
Cleaning the drip tray	8		
Cleaning the water tank.....	8		
Cleaning the spouts	8		
Cleaning the pre-ground coffee funnel	8		
Cleaning the inside of the coffee maker	8		
Cleaning the brewing unit	8		
Cleaning the milk container	8		
CHANGING AND SETTING MENU PARAMETERS	9		
Setting the language	9		
Rinsing	9		
Changing the length of time the appliance remains on	9		
Setting the clock	9		
Setting auto-start time	9		

INTRODUCTION

Thank you for choosing the automatic coffee and cappuccino maker. We hope you enjoy using your new appliance. Take a few minutes to read these instructions. This will avoid all risks and damage to the machine.

Symbols used in these instructions

Important warnings are identified by these symbols. It is vital to respect these warnings. Failure to observe the instructions could result in electric shock, serious injury, burns, fire or damage to the appliance.



Failure to observe the warning could result in possibly life threatening injury from electric shock.



Failure to observe the warning could result in injury or damage to the appliance.



Failure to observe the warning could result in scalds or burns.



This symbol identifies important advice or information for the user.

Letters in brackets

The letters in brackets refer to the legend in the Description of the Appliance on page 3.

Troubleshooting and repairs

In the event of problems, first try and resolve them following the information given in the sections "Displayed messages" and "Troubleshooting". If this does not resolve the problem or you require further information, you should consult Customer Services by calling the number given on the "Customer Service" sheet. If your country is not among those listed on the sheet, call the number given in the guarantee. If repairs are required, contact Customer Services only. The addresses are given in the guarantee certificate provided with the machine.

SAFETY

Fundamental safety warnings

The appliance is not intended for use by persons (including children) with reduced physical, sensory or mental capabilities, or lack of experience and knowledge, unless they have been given supervision or instruction concerning use of the appliance by a person responsible for their safety.

Children should be supervised to ensure that they do not play with the appliance.

Designated use: this appliance is designed and made to prepare coffee and milk based beverages and hot water. Any other use is considered improper and thus dangerous. The manufacturer is not liable for damage deriving from improper use of the appliance.

The surface of the heating element remains hot after use and the outside of the appliance may retain the heat for several minutes depending on use.

Clean all the components thoroughly, taking particular care with parts in contact with the coffee and milk.

Cleaning and user maintenance shall not be made by children without supervision.

Never immerse the appliance in water.

CAUTION: To prevent damage to the appliance do not use alkaline cleaning agents when cleaning, use a soft cloth and a mild detergent

This is an household appliance only. It is not intended to be used in: staff kitchen areas in shops, offices and other working environments; farm houses; by clients in hotels, motels and other residential type environments; bed and breakfast type environments.

If the plug or power cable is damaged, it must be replaced by customer services only to avoid all risk.

Appliances with removable cord: avoid splashes of water on the power cord connector or socket at the back of the appliance.

WARNING: Models with glass surfaces: do not use the appliance if the surface is cracked.

FOR EUROPEAN MARKETS ONLY:

This appliance can be used by children aged from 8 years and above if they have been given supervision or instruction concerning use of the appliance in a safe way and if they understand the hazard involved. Cleaning and user maintenance shall not be made by children unless they are older than 8 and supervised. Keep the appliance and its cord out of the reach of children aged less than 8 years.

Appliances can be used by persons with reduced physical, sensory or mental capabilities or lack of experience and knowledge if they have been given supervision or instruction concerning use of the appliance in a safe way and understand the hazards involved.

Children shall not play with the appliance.

When not in use and before cleaning, always unplug the appliance.



Surfaces marked with this symbol become hot during use (the symbol is present in certain models only).



Danger! This is an electrical appliance, it is therefore important to respect the following safety warnings:

- Never touch the appliance with damp hands.
- Never touch the plug with damp hands.
- Make sure the socket used is freely accessible at all times, enabling the appliance to be unplugged when necessary.
- Unplug directly from the plug only.
Never pull the power cable as you could damage it.
- To disconnect the appliance completely, place the main switch (A23) on the side of the appliance in the 0 position.
- If the appliance is faulty, do not attempt to repair.
Turn it off using the main switch (A23), unplug from the mains socket and contact Customer Services.



Important! Keep all packaging (plastic bags, polystyrene foam) away from children.



Danger of burns! This appliance produces hot water and steam may form while it is in operation.

Avoid contact with splashes of water or hot steam.

Use knobs and handles.



Important! Do not grasp the coffee maker when it is out of the cabinet.

Do not rest recipients containing liquids or inflammable or corrosive materials on top of the appliance. Place the accessories required to make the coffee (the measure for example) in the special holder.

Do not rest large objects which could obstruct movement or unstable objects on the appliance.

Do not allow children and animals to stop or linger near the appliance when it is pulled out of the cabinet.

Do not leave the machine pulled out of the cabinet when it is being used.

Do not leave the machine pulled out of the cabinet when it is not needed.

Install the machine according to the instructions in the handbook to guarantee there are no spills when it is pulled out from the cabinet.

 **Important!** Do not use the appliance when extracted. Make sure the appliance is inactive before extracting it.
The only exception is adjusting the coffee mill which must be done with the machine out (see the section "Adjusting the coffee mill").

 **N.B.:** Use original or manufacturer recommended accessories and spare parts only.

Designated use

This appliance is designed and made to prepare coffee and heat drinks.

All other use is considered improper.

This appliance is not suitable for commercial use.

The manufacturer is not liable for damage deriving from improper use of the appliance. This appliance can be installed over a built-in oven if the latter is fitted with a cooling fan at the rear (maximum microwave power: 3 kW).

Instructions

Read these instructions carefully before using the appliance.

- Keep these instructions
- Failure to respect these instructions may result in burns or damage to the appliance.
The manufacturer is not liable for damage deriving from failure to respect these instructions.

 **N.B.!** The appliance has a cooling fan.

This comes on whenever coffee, steam or hot water is delivered.

After several minutes, the fan goes off automatically.

DESCRIPTION

Description of the appliance

(page 3 - A)

- A1. Cup tray
- A2. Service door
- A3. Coffee guide
- A4. Waste coffee container
- A5. Brewing unit
- A6. Cup tray lights
- A7. On/OFF/stand-by button
- A8. Control panel
- A9. Tray
- A10. Hot water and steam nozzle
- A11. IEC connector
- A12. Water tank
- A13. Coffee spout (adjustable height)
- A14. Drip tray
- A15. Bean container lid
- A16. Bean container
- A17. Grinding adjustment knob
- A18. Pre-ground coffee funnel door
- A19. Measure
- A20. Compartment for measure
- A21. Pre-ground coffee funnel
- A22. Power cable
- A23. Main switch

Description of the control panel









(page 3 - B)

 **N.B.!** Only icons B6, B7, B8, B9 and B14 concerning the enabled commands will light up on the control panel.

 **N.B.!** A light touch is enough to activate the icon.

B1. Display: guides the user in using the appliance.

B2.  icon to activate or deactivate menu parameter setting mode

- B3.  icon to turn lights A6 on and off
- B4.  icon to select the coffee taste
- B5.  icon to select the type of coffee (espresso, small cup, medium cup, large cup, mug)
- B6. ESC icon to exit the selected mode
- B7-B8.   icons to scroll forwards or backwards through the menu and display the various modes
- B9. OK icon to confirm the selected function
- B10.  icon to deliver a cup of coffee
- B11.  icon to deliver two cups of coffee
- B12.  icon to deliver cappuccino
- B13.  icon to deliver hot water

Description of milk container and accessories

(page 3 - C)

- C1. Frothed milk regulator
- C2. Milk container handle
- C3. CLEAN button
- C4. Milk intake tube
- C5. Frothed milk spout
- C6. Milk frother
- C7. Hot water spout

PRELIMINARY CHECKS

Controls after transport

After removing the packaging, make sure the product is complete and undamaged and that all accessories are present. Do not use the appliance if it is visibly damaged. Contact Customer Services.

Installing the appliance

 **Important!**

- Installation must be performed by a qualified professional in compliance with legislation in force in the country of installation (see Built-in installation).
- The packing elements (plastic bags, polystyrene foam, etc.) should be kept out of reach of children.
- Do not install the appliance in rooms where the temperature may drop to 0°C or lower.
- Customise the water hardness as soon as possible following the instructions in the "Setting water hardness" section.

Connecting the appliance

 **Danger!** Check that the mains power supply voltage corresponds to the value indicated on the rating plate on the bottom of the appliance.

Connect the appliance to an efficiently earthed and correctly installed socket with a minimum current rating of 10A only.

If the power socket does not match the plug on the appliance, have the socket replaced with a suitable type by a qualified professional. To comply with safety directives, an omnipolar switch with a minimum contact distance of 3 mm must be installed.

Do not use multiple sockets or extensions.

 **Important!** Safety cutout devices must be included in the mains power supply in compliance with the installation regulations in the country concerned.

Disposing of the appliance

 The appliance must not be disposed of with household waste, but taken to an authorised waste separation and recycling centre.

BUILT-IN INSTALLATION

Check the minimum measurements required for correct installation of the appliance. The coffee machine must be installed in a column unit, which must in turn be securely fixed to the wall by means of commercial brackets.

Attention:

- Disconnect the appliance from the mains before carrying out any installation work or servicing.
- Kitchen units in contact with the appliance must be heat resistant (min. 65°C).
- To ensure adequate ventilation, provide an opening on the bottom of the housing (see dimensions in Figure).

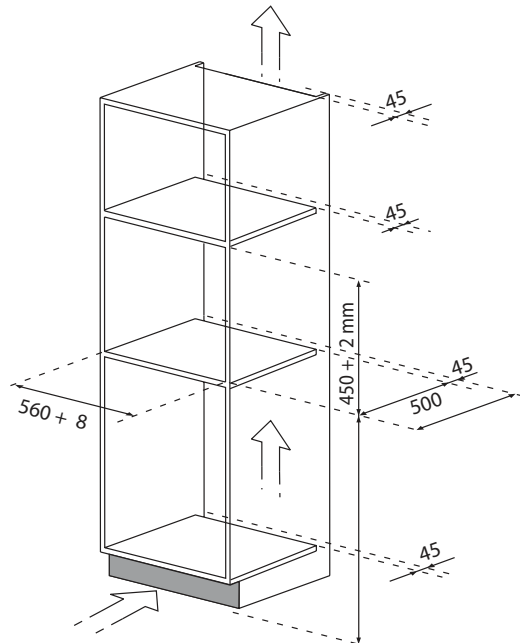
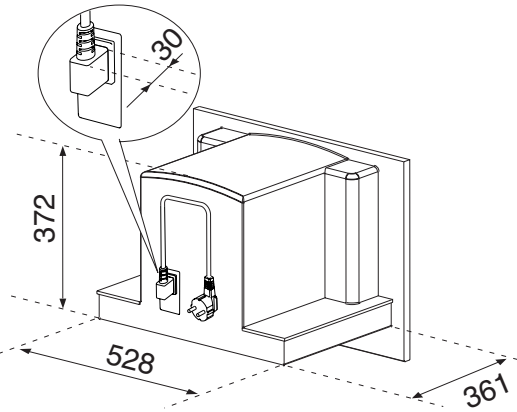
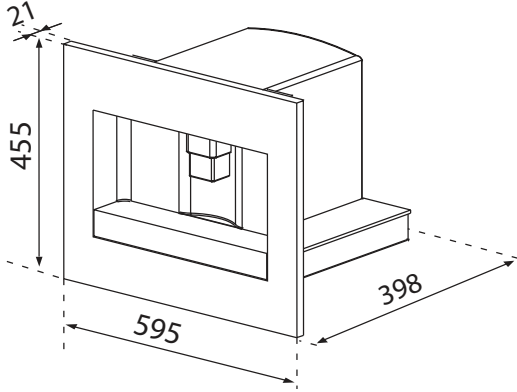

Position the runners on the sides of the housing, as shown in the Figure. Secure the runners with the screws supplied, then pull them out to full extension. If the coffee machine is installed above a "warmer drawer", use the top of the latter as a reference for positioning the runners. In this case, there will be no support surface.

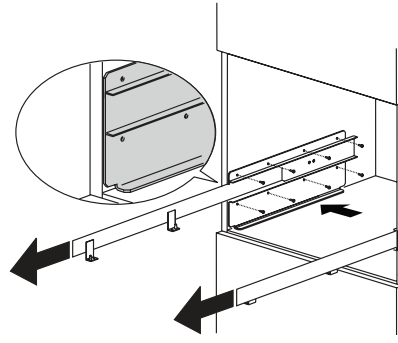
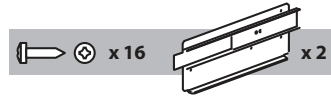

Secure the power supply cable with the clip provided. The power supply cable must be long enough to allow the machine to be removed from the housing in order to fill the coffee bean container. Regulations require that the appliance is earthed. Electrical connection must be carried out by a qualified electrician in accordance with the manufacturer's instructions.

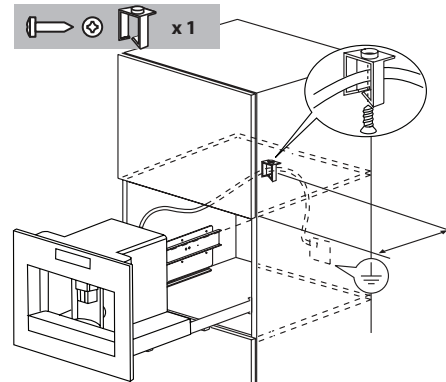

Position the machine on the runners, making sure that the pins engage properly in their seats before securing with the screws provided.

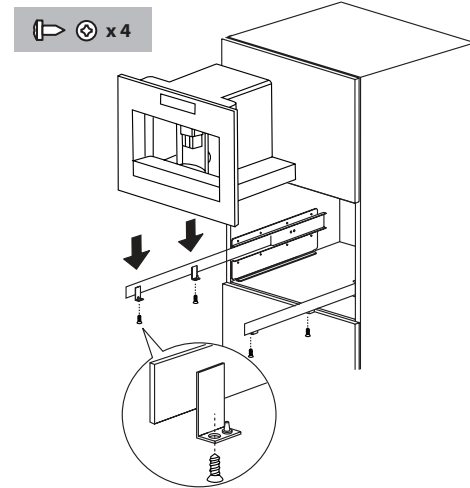

If machine alignment requires adjustment, position the spacers provided either below or at the side of the support. The rail fixing panel must have a thickness suited to the fixing screws provided. The panel material must be suited to the machine weight of approximately 25kg.

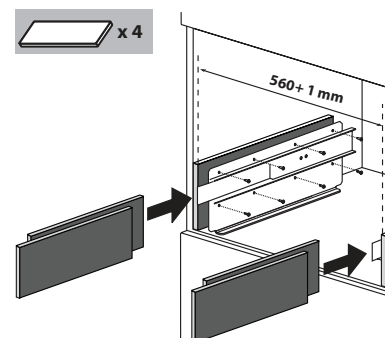

USING THE APPLIANCE FOR THE FIRST TIME

- Coffee has been used to factory test the appliance and it is therefore completely normal for there to be traces of coffee in the mill.
 - Customise water hardness as soon as possible following the instructions in the "Setting water hardness" section.
1. Connect the appliance to the mains supply.
Set the required language.
 2. To set the language, use the ◀ ▶ icons (B7 and B8) to choose the required language (fig. 2). When the message "PRESS OK TO CHOOSE ENGLISH" is displayed, press the OK icon (B9) (fig. 3) for 3 seconds until "ENGLISH INSTALLED" is displayed. If you set the wrong language, follow the instructions in the "Setting the language" section.
If your language is not available, select one from those displayed. The instructions refer to the English version.
Then follow the instructions displayed:
 3. After 5 seconds, the appliance displays "FILL TANK". Extract the water tank (fig. 4), rinse and fill with fresh water without exceeding the MAX line. Replace and push as far as it will go.
 4. Place a cup under the hot water spout (fig. 5). (If the hot water spout is not inserted, the appliance displays "INSERT WATER SPOUT". Attach it as shown in figure 6.
The appliance displays: "HOT WATER PRESS OK".
Press the OK icon (B9) (fig. 3) and after a few seconds a little water comes out of the spout.
 5. The machine now displays "TURNING OFF... PLEASE WAIT" and goes off.
 6. Extract the appliance by pulling it out using the handles (fig. 7). Open the lid and fill the container with coffee beans, then close the lid and push the appliance in.
The coffee maker is now ready for normal use.

 **Important!** Never introduce pre-ground coffee, freeze dried coffee, caramelised beans or anything else which could damage the appliance.

 **N.B.!** When using the appliance for the first time, you need to make 4-5 cups of coffee and 4-5 cappuccinos before the appliance gives satisfactory results.

 **N.B.!** Each time you turn the coffee maker on by the ON/OFF switch (A23), it performs a SELF-DIAGNOSIS cycle and then goes off. To turn it on again, press the ON/OFF button (A7) (fig. 1)

TURNING ON AND HEATING UP

Each time the appliance is turned on, it performs an automatic preheat and rinse cycle which cannot be interrupted. The appliance is ready for use only after completion of this cycle.

 **Danger of burns!** During rinsing, a little hot water flows from the coffee spouts.

To turn the appliance on, press the ON/OFF/stand-by button (A7) (fig. 1). The message "HEATING UP... PLEASE WAIT" is displayed.

When heating is complete, the message changes to "RINSING";

The appliance is at temperature when the message "MEDIUM CUP NORMAL TASTE" is displayed.

If no icon is pressed within about 2 minutes, the time (if set, see the "Setting the clock" section) is displayed.

If the time has not been set, the appliance displays the last functions set.

When any icon is pressed, "MEDIUM CUP NORMAL TASTE" is displayed again. The appliance is ready to make coffee again.

MAKING COFFEE USING COFFEE BEANS

1. The appliance is preset to make coffee with a normal taste. You can also choose coffee with an extra-mild, mild, strong or extra-strong taste. There is also a pre-ground coffee option. To choose the required taste, press the ☐ icon (B4) (fig. 8) a number of times. The required coffee taste is displayed.
2. Place 1 cup under the spouts to make 1 coffee (fig. 9) or 2 cups for 2 coffees (fig. 9). Lower the spouts as near as possible to the cup for a creamier coffee (fig. 10).
3. Press the ☐ icon (B5) (fig. 11) to select the type of coffee: espresso, small cup, medium cup, large cup, mug. Now press the ☐ icon (B10) (fig. 12) if you want to make a coffee and the ☐ icon (B11) (fig. 13) if you want to make 2 coffees. The appliance now grinds the beans and starts delivering the coffee into the cup.
Once the set amount of coffee has been delivered, the machine stops delivery automatically and expels the exhausted waste coffee into the waste coffee container.
4. After a few seconds, the appliance is ready for use again.
5. To turn the appliance off, press the ON/OFF/stand-by button (A7) (fig. 1). (Before going off, the appliance performs an automatic rinse cycle. Take care to avoid scalds).

NOTE 1: If the coffee is delivered a drop at a time or not at all, see the "Adjusting the coffee mill"

section.

NOTE 2: If the coffee is delivered too fast and the cream is not satisfactory, see the "Adjusting the coffee mill" section.

NOTE 3: Tips for a hotter coffee:

- Proceed as described in the section "Changing and setting menu parameters", "Rinse" function.
- Unless preheated, do not use excessively thick cups as they will absorb too much heat.
- Preheat the cups by rinsing them with hot water.

NOTE 4: Coffee delivery can be interrupted at any moment by re-pressing the previously selected icon which remains lit during the operation.

NOTE 5: As soon as delivery is finished, to increase the quantity of coffee in the cup, just keep pressing the previously selected icon within 3 seconds after delivery has finished.

NOTE 6: When the appliance displays "FILL TANK", fill the tank with water or the appliance will not deliver coffee.

(It is normal for there to be a little water left in the tank).

NOTE 7: After about 14 single (or 7 double) coffees, the appliance displays "EMPTY WASTE COFFEE CONTAINER".

Even if not full, the empty waste coffee container message is displayed 72 hours after the first coffee has been delivered. For the 72 hours to be calculated correctly, the machine must never be turned off with the main switch in the 0 position.

To clean, open the service door on the front of the appliance by pulling the spout (fig. 16), extract the drip tray (fig. 17) and clean.

When cleaning, always extract the drip tray completely.

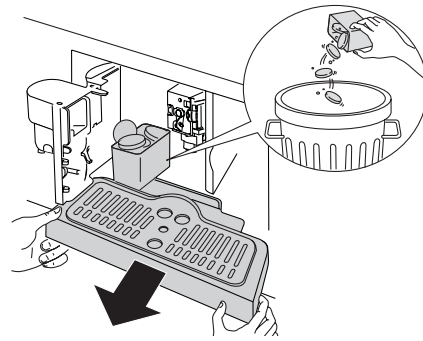

 **Important!** When extracting the drip tray, the waste coffee container MUST always be emptied.

If this is not done, the machine may be clogged.

NOTE 8: Never extract the water tank while the machine is delivering coffee.

If it is removed, it will not be possible to make the coffee and the appliance will display "GROUND TOO FINE ADJUST MILL AND PRESS OK" and then "FILL TANK". Check the level of water in the tank and replace in the appliance.

To turn the appliance back on, insert the water spout if not already in place (fig. 6), then press the OK icon (B9). "HOT WATER PRESS OK" is displayed.

Press the OK icon (B9) within a few seconds and deliver water from the spout for about 30 seconds. When delivery stops, the basic modes are displayed again.

 **N.B.:** The coffee maker may request the operation to be repeated a number of times until the air is completely eliminated from the hydraulic circuit.

 **N.B.:** if this operation is not performed correctly or if the machine is turned off, the basic modes may be displayed, although the problem is in fact still present.

CHANGING THE QUANTITY OF COFFEE IN THE CUP

The appliance is set by default to automatically make the following types of coffee:

- espresso
- small cup
- medium cup
- large cup
- mug

To change the quantity, proceed as follows:

- Press the ☐ icon (B2) to enter the menu (fig. 15). Press the ◀ ▶ icons (B7) and (B8) (fig. 2) until "PROGRAM COFFEE" is displayed.
- Press the OK icon (B9).
- Select the type of coffee you want to change by pressing the ◀ ▶ icons (B7) and (B8).
- Press the OK icon (B9) to confirm the type of coffee you want to make.

- Use the ◀ ▶ icons (B7) and (B8) to change the quantity of coffee. The progress bar shows the quantity of coffee selected.
 - Press the OK icon (B9) again to confirm (or the icon (B6) to cancel the operation).
 - Press the ESC (B6) icon (B6) (fig. 18) twice to exit the menu.
- The appliance is now reprogrammed with the new settings and is ready.

ADJUSTING THE COFFEE MILL

The coffee mill is preset in the factory and should not require adjusting. However, if after making the first few coffees you find that delivery is either too fast or too slow (a drop at a time), this can be corrected by adjusting the grinding adjustment knob (fig. 14).

 **Important!** The grinding adjustment knob must only be turned when the coffee mill is in operation.

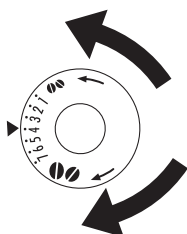

For slower delivery and creamier coffee, turn one click anticlockwise (finer pre-ground coffee). For faster delivery (not a drop at a time), turn one click clockwise (coarser pre-ground coffee).

PREPARING COFFEE WITH PRE-GROUND COFFEE (INSTEAD OF BEANS)

- Press the ☑ (B4) icon (B4) (fig. 8) and select the pre-ground coffee function.
 - Extract the machine by pulling it outwards using the handles (fig. 7).
 - Lift the central lid, place one measure of pre-ground coffee in the funnel (fig. 19), push the appliance in then proceed as described in the section "Making coffee using coffee beans".
- N.B.: You can make just one coffee at a time by pressing the ☑ (B10) icon (B10) (fig. 12).
- After using the machine with pre-ground coffee, to go back to making coffee using beans, deactivate the pre-ground coffee function by pressing the ☑ (B4) icon (B4) (fig. 8).

NOTE 1: Never introduce pre-ground coffee when the machine is off or it could spread through the inside of the appliance.

NOTE 2: Never add more than 1 measure, otherwise the appliance will not make the coffee.

NOTE 3: Use the measure provided only.

NOTE 4: Introduce only pre-ground coffee for espresso coffee machines into the funnel.

NOTE 5: If more than one measure of pre-ground coffee is used and the funnel clogs, push the coffee down with a knife (fig. 21) then remove and clean the brewing unit and machine as described in the "Cleaning the brewing unit" section.

DELIVERING HOT WATER

- Always make sure the appliance is ready.
- Make sure the hot water spout is in place (fig. 6). Position a container under the spout.
- Press the ☑ (B13) icon (B13) (fig. 20). The appliance displays: "HOT WATER PRESS OK". Press the OK icon (B9) again and hot water is delivered from the hot water spout into the container underneath. (You should not deliver hot water for more than 2 minutes at a time). To interrupt, press the ☑ (B13) icon (B13) or the ESC icon (B6). The appliance stops delivery once the set quantity is reached.

CHANGING THE QUANTITY OF HOT WATER

The machine is set by default to automatically delivery 200 ml of hot water.

To change these quantities, proceed as follows:

- Place a container underneath the cappuccino maker (fig. 5).
- Press the ☑ (B2) to enter the menu (fig. 15) or press the ◀ ▶ icons (B7) and (B8) (fig. 2) until "PROGRAM HOT WATER" is displayed.
- Press the OK icon (B9) to confirm.
- Select the required quantity of water by pressing the ◀ ▶ icons (B7) and (B8). The progress bar shows the quantity of water selected.
- Press the OK icon (B9) to confirm (or the ESC icon (B6) to cancel the operation).
- Press the ESC (B6) icon (B6) (fig. 18) twice to exit the menu.
- The appliance is now reprogrammed with the new settings and is ready.

MAKING CAPPUCCINO

 **N.B.:** Set the quantity of coffee you want to use to make the cappuccino in the "Program cappuccino" function in the menu.

- Select the taste of the coffee you want to use to make the cappuccino by pressing the ☑ (B4) icon (B4).
- Remove the lid of the milk container.
- Fill the container with about 100 grams of milk for each cappuccino to be prepared (fig. 23). Never exceed the MAX level (corresponding to about 750 ml) marked on the container. You should ideally use skimmed or semi-skimmed milk at refrigerator temperature (about 5°C).
- Make sure the intake tube is correctly inserted in the rubber washer (fig. 24) then replace the milk container lid.
- Position the frothed milk regulator (C1) between the words CAPPUCCINO and CAFFELATTE printed on the milk container lid. The quantity of froth can be adjusted by moving the regulator towards the word CAFFELATTE for a denser froth. Moving it towards the word CAPPUCCINO obtains a less dense froth.

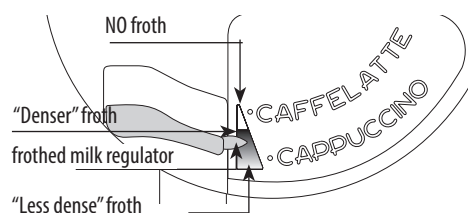

- Remove the hot water spout (fig 6) and attach the milk container to the nozzle (fig. 25).
- Position the milk spout as shown in fig. 26 and then place a sufficiently large cup under the coffee and milk spouts.
- Press the ☑ (B12) icon (fig. B12). "CAPPUCCINO" is displayed and after a few seconds, frothed milk flows out of the milk spout into the cup below. (La fuoriuscita del latte si interrompe automaticamente). (Delivery stops automatically).
- The appliance delivers coffee.
- The cappuccino is now ready. Sweeten to taste and, if desired, sprinkle the froth with a little cocoa powder.

NOTE 1: While making cappuccino, the flow of frothed milk or coffee can be interrupted by pressing the ☑ (B12) icon (B12).

NOTE 2: If the milk in the container finishes while delivering frothed milk, remove the container and add milk. Reattach and press the ☑ (B12) to request a cappuccino again.

NOTE 3: To ensure the complete cleanliness and hygiene of the milk frother, always clean the circuits in the milk container lid after making cappuccino.

"PRESS CLEAN!" flashes on the display.

- Place a recipient under the milk spout (fig. 26).
- Press the CLEAN button on the lid (C3) and hold down for at least 5 seconds (fig. 26) to start the cleaning function. The appliance displays the message "CLEANING!" above a progressive bar. You should not release the CLEAN button until the bar is complete indicating that cleaning is concluded. When the CLEAN button is released, the function stops. After cleaning, remove the milk container and place in the refrigerator. The milk should not be left out of the refrigerator for more than 15 minutes.

NOTE 4: To change the quantity of coffee or frothed milk the appliance delivers automatically into the cup, proceed as described in the section "Changing the quantity of coffee and milk for cappuccino".

CHANGING THE QUANTITY OF COFFEE AND MILK FOR CAPPUCCINO

The appliance is set by default to automatically deliver a normal cappuccino.

To change these quantities, proceed as follows:

Changing the quantity of milk

- Fill the container with milk up to the maximum level indicated on the container.
- Press the ☑ (B2) icon (B2) to enter the menu (fig. 15), then press the ◀ ▶ icons (B7) and (B8) (fig. 2) until "PROGRAM CAPPUCCINO" is displayed.
- Press the OK icon (B9) to confirm. "PROGRAM MILK" is displayed.
- Press the OK icon (B9) again.

- Select the quantity of milk required by pressing the ◀ ▶ icons (B7) and (B8). The progress bar shows the quantity of milk selected.
- Press the OK icon (B9) to confirm (or the ESC icon (B6) to cancel the operation).
- Press the ESC (B6) icon (B6) (fig. 18) twice to exit the menu.

Changing the quantity of coffee

- Press the [M] (B2) icon (B2) to enter the menu (fig. 15), then press the ◀ ▶ icons (B7) and (B8) (fig. 2) until "PROGRAM CAPPUCCINO" is displayed.
- Press the OK icon (B9) to confirm then the ◀ ▶ icons (B7) and (B8) (fig. 2) until "COFFEE FOR CAPPUCC." is displayed.
- Press the OK icon (B9) again.
- Select the quantity of coffee required by pressing the ◀ ▶ icons (B7) and (B8). The progress bar shows the quantity of coffee selected.
- Press the OK icon (B9) to confirm (or the ESC icon (B6) to cancel the operation).
- Press the ESC icon (B6) (fig. 18) twice to exit the menu.

CLEANING

Cleaning the coffee maker

Do not use solvents or abrasive detergents to clean the coffee maker. A soft damp cloth will suffice.

Never wash any of the components of the coffee maker in the dishwasher.

The following parts of the machine must be cleaned regularly:

- Waste coffee container (A4).
- Drip tray (A14).
- Water tank (A12).
- Coffee spouts (A13)
- Pre-ground coffee funnel (A21).
- Inside of the machine, accessible after opening the service door (A2).
- Brewing unit (A5).

Cleaning the waste coffee container

When "EMPTY WASTE COFFEE CONTAINER" is displayed, the waste coffee container must be emptied and cleaned.

To clean:

- open the service door on the front of the appliance (fig. 16), extract the drip tray (fig. 17) and clean.
- Clean the waste coffee container thoroughly.

! **Important!** When extracting the drip tray, the waste coffee container **must** always be emptied.

Cleaning the drip tray

! **Important!** If the drip tray is not emptied the water might overflow. This could damage the machine.

The drip tray is fitted with a level indicator (red) showing the level of water it contains (fig. 28). Before the indicator protrudes from the cup tray, the drip tray must be emptied and cleaned.

To remove the tray:

1. Open the service door (fig. 16).
2. Remove the drip tray and the waste coffee container (fig. 17).
3. Clean the drip tray and waste coffee container (A4).
4. Replace the drip tray and waste coffee container (A4).
5. Close the service door.

Cleaning the water tank

1. Clean the water tank (A12) regularly (about once a month) with a damp cloth and a little mild washing up liquid.
2. Remove all traces of washing up liquid.

Cleaning the spouts

1. Clean the nozzles periodically using a sponge.
2. Check regularly that the holes in the coffee spout are not blocked. If necessary, remove coffee deposits with a toothpick (fig. 27).

Cleaning the pre-ground coffee funnel

- Check regularly (about once a month) that the pre-ground coffee funnel is not blocked (fig.

21).

! **Danger!** Before performing any cleaning operations, the machine must be turned off by pressing the main switch (A23) and unplugged from the mains power supply. Never immerse the coffee maker in water.

Cleaning the inside of the coffee maker

1. Check regularly (about once a week) that the inside of the appliance is not dirty. If necessary, remove coffee deposits with a sponge.
2. Remove the residues with a vacuum cleaner (fig. 30).

Cleaning the brewing unit

The brewing unit must be cleaned at least once a month.

! **Important!** The brewing unit (A5) must not be removed when the appliance is on. Do not use force to remove the brewing unit.

1. Make sure the machine is correctly turned off (see "Turning the appliance off").
2. Open the service door (fig. 16).
3. Remove the drip tray and waste coffee container (fig. 17);
4. Press the two red release buttons inwards and at the same time pull the brewing unit outwards (fig. 31).

! **Important!** Do not use washing up liquid to clean the brewing unit. It would remove the lubricant applied to the inside of the piston.

5. Soak the brewing unit in water for about 5 minutes, then rinse.
6. After cleaning, replace the brewing unit (A5) by sliding it onto the internal support and pin at the bottom, then push the PUSH symbol fully in until it clicks into place.

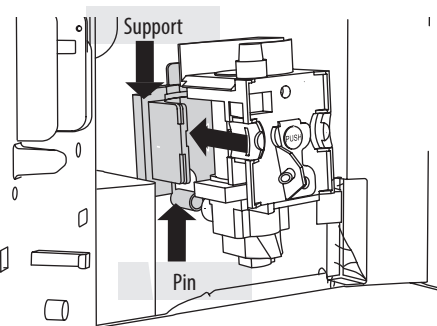

i **N.B.:** If the brewing unit is difficult to insert, you must first adapt it to the right dimensions by pressing it forcefully from the bottom and top as shown in the figure.

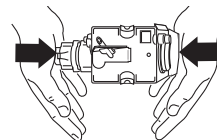

7. Once inserted, make sure the two red buttons have snapped out.

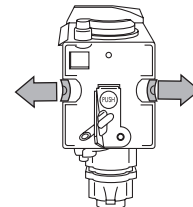

8. Replace the drip tray and waste coffee container.
9. Close the service door.

Cleaning the milk container

! **Important!** Always clean the tubes inside the milk container (C) when you prepare milk. If there is still milk in the container, do not leave it out of the refrigerator for longer than strictly necessary.

Clean the container each time you prepare milk as described in Note 3 in the section “Making cappuccino”.

All components can be washed in a dishwasher, placing them in the top basket of the dishwasher.

1. Turn the lid of the milk container clockwise then remove it.
2. Remove the milk spout and intake tube.

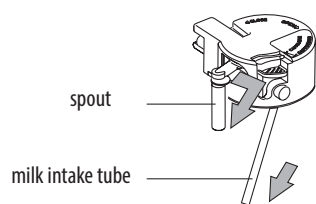

Groove

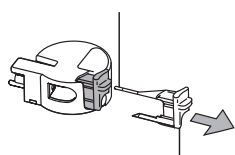

Frothed milk regulator

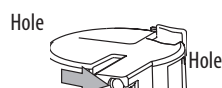

3. Remove the frothed milk regulator by pulling it outwards.
4. Wash all the components thoroughly with hot water and mild washing-up liquid. Make sure there are no milk residues left inside the holes and the groove on the fine end of the frothed milk regulator.
5. Check that the intake tube and spout are not clogged with milk residues.
6. Replace the frothed milk regulator, milk spout and intake tube.
7. Replace the milk container lid.

CHANGING AND SETTING MENU PARAMETERS

When the appliance is ready, you can use the internal menu to modify the following parameters and functions:

- Choose language
- Rinsing
- Shut-off time
- Set clock
- Start time
- Auto-start
- Temperature
- Water hardness
- Program coffee
- Program cappuccino
- Program jug (certain models only)
- Program water
- Descale
- Reset to default
- Statistics
- Buzzer
- Contrast

Setting the language

To change the language on the display, proceed as follows:

- Press the **M** icon (B2) to enter the menu. “CHOOSE LANGUAGE” is displayed.
- Press the OK icon (B9).
- Press the **◀ ▶** icons (B7) and (B8) until the required language is displayed.
- Press the OK icon (B9) to confirm.
- Press the ESC (B6) to exit the menu.



N.B.: If you choose the wrong language, you can access the menu directly to modify the parameter.

- Press the **M** (B2) for at least 7 seconds until the appliance displays the various languages.
- Choose the required language as described in the section “Using the appliance for the first

time”.

Rinsing

This function enables you to obtain hotter coffee.

Proceed as follows:

- When you turn the appliance on, if you want to make a small cup of coffee (less than 60 cc), preheat the cup by rinsing it with hot water.
- If on the other hand more than 2/3 minutes have passed since the last coffee was made, before requesting another coffee, you must preheat the brewing unit by first pressing the **M** icon (B2) to enter the menu then the **◀ ▶** icons (B7) and (B8) to select the “RINSING” function. Press the OK icon (B9). “RINSING... PLEASE CONFIRM” is displayed. Press the OK icon (B9) again. Deliver the water into the underlying drip tray or alternatively use this water to fill (and then empty) the cup to be used for the coffee to preheat it.

Changing the length of time the appliance remains on

The appliance is set by default to go off automatically 30 minutes after the last coffee has been made.

To change this interval (max. 120 min), proceed as follows:

- Press the **M** icon (B2) to enter the menu and then the **◀ ▶** icons (B7) and (B8) until “SHUT-OFF TIME” is displayed.
- Press the OK icon (B9) to confirm.
- Press the **◀ ▶** icons (B7) and (B8) to set the time after which the appliance will go off (after 1/2 hour, 1 hour, 2 hours).
- Press the OK icon (B9) to confirm.
- Press the ESC icon (B6) to exit.

Setting the clock

- Press the **M** icon (B2) to enter the menu and then the **◀ ▶** icons (B7) and (B8) until “SET CLOCK” is displayed.
- Press the OK icon (B9).
- Use the **◀ ▶** icons (B7) and (B8) to set the hour, then press the OK icon (B9) to confirm.
- Use the **◀ ▶** icons (B7) and (B8) to set the minutes, then press the OK icon (B9) to confirm.
- Press the ESC (B6) icon (B6) to exit the menu.

Setting auto-start time

This function programmes the time the machine will come on automatically.

- Make sure the clock on the appliance has been set.
- Press the **M** icon (B2) to enter the menu and then the **◀ ▶** icons (B7) and (B8) until “START TIME” is displayed.
- Press the OK icon (B9).
- Use the **◀ ▶** icons (B7) and (B8) to set the auto-start time, then press the OK icon (B9) to confirm.
- Use the **◀ ▶** icons (B7) and (B8) to set the minutes, then press the OK icon (B9) to confirm.
- Press the **◀ ▶** icons (B7) and (B8) to activate the auto-start function until “AUTO START” is displayed.
- “AUTO START PLEASE CONFIRM” is displayed. PRESS THE OK ICON (B9). The **⏻** symbol appears on the display.
- Press the ESC (B6) icon (B6) to exit the menu.
- To disable auto-start, press the **M** icon (B2), then the **◀ ▶** icons (B7) and (B8) until “AUTO START” is displayed. Press the OK icon (B9). “PLEASE CONFIRM” is displayed. Press (B6) to disable, the ESC symbol disappears **⏻**.

Changing coffee temperature





To change coffee temperature, proceed as follows:

- Press the **M** icon (B2) to enter the menu and then the **◀ ▶** icons (B7) and (B8) until “TEMPERATURE” is displayed.
- Press the OK icon (B9).
- Press the **◀ ▶** icons (B7) and (B8) to select the required coffee temperature from low, medium and high.
- Press the OK button (B9) to confirm the temperature selected.
- Press the ESC icon (B6) to exit the menu.

Setting water hardness

The operating period can be extended if required, making descaling less frequent by programming the machine on the basis of the real lime content in the water used.

Proceed as follows:

- remove the "Total Hardness Test" strip (attached to page 2) from its packaging then dip it fully in the water for a few seconds, Then remove and wait about 30 seconds (until it changes colour and forms red squares).
- turn the appliance on by pressing the ON/OFF/stand-by button (A7).
- Press the  icon (B2) to enter the menu and then the   icons (B7) and (B8) until "WATER HARDNESS" is displayed.
- Press the OK icon (B9).
- Press the   icons (B7) and (B8) until the number coincides with the number of red squares on the test strip (for example, if there are 3 red squares on the test strip, select the message "WATER HARDNESS 3")
- Press the OK icon (B9) to confirm.
The coffee maker is now programmed to provide the descale warning when actually necessary.

Programming coffee

For instructions on programming coffee, see the "CHANGING THE QUANTITY OF COFFEE IN THE CUP" section.

Programming cappuccino

For instructions on programming cappuccino, see the section "CHANGING THE QUANTITY OF MILK AND COFFEE FOR CAPPUCCINO".

Programming water

For instructions, see the "CHANGING THE QUANTITY OF HOT WATER" section.

Descaling



Important!

Respect the safety warnings provided by the manufacturer and given on the descaler pack.





N.B.: Use the descaler recommended by the manufacturer only.

Use of other descalers invalidates the guarantee.

Failure to descale the appliance as described also invalidates the guarantee.

When "PLEASE DESCALE!" is displayed, the machine requires descaling.

Proceed as follows:



- make sure the machine is ready;
- Press the  icon (B2) to enter the menu and then the   icons (B7) and (B8) until "DESCALE" is displayed.
- Press the OK icon (B9).
The message "ADD DESCALER PLEASE CONFIRM" is displayed.
- Empty the tank of water, pour the contents of the descaler bottle into the tank respecting the instructions given on the descaler pack, then add water.
Position a container with a capacity of 2 litres under the hot water spout.
- Press the OK icon (B9). Descaler flows out of the hot water spout into the container below. The appliance displays: "DESCALING".
- The descale programme automatically performs a series of deliveries and pauses.
- After about 30 minutes "DESCALE COMPLETE PLEASE CONFIRM" is displayed.
- Press the OK icon (B9). "RINSING FILL TANK" is displayed.
- Empty the water tank, rinse to eliminate descaler residues, then fill with clean water.
- Replace the tank full of clean water.
"RINSING PLEASE CONFIRM" is displayed again.
- Press the OK icon (B9) again.
Hot water flows out of the spout into the container below and "RINSING" is displayed.
- Wait until "RINSING COMPLETE PLEASE CONFIRM" is displayed.
- Press the OK icon (B9).
"DESCALE COMPLETE" is displayed, then "FILL TANK!".
Fill the tank again with clean water.
- The descale programme is now terminated and the appliance is ready to make coffee again.
NOTE: If descaling is interrupted before completion, the process must be begun again from the beginning.



Important! FAILURE TO DESCALE THE APPLIANCE REGULARLY INVALIDATES THE GUARANTEE.

Resetting default values (reset)





If you change the original values, the default values can be reset as follows:

- Press the  icon (B2) to enter the menu and then the   icons (B7) and (B8) until "RESET TO DEFAULT" is displayed.
- Press the OK icon (B9) and the appliance displays "RESET TO DEFAULT PLEASE CONFIRM".
- press the OK button (B9) to reset the default values;

Statistics

This displays statistics relating to the machine.

To display, proceed as follows:



- Press the  icon (B2) to enter the menu and then the   icons (B7) and (B8) until "STATISTICS" is displayed.
- Press the OK icon (B9).
- Press the   icons (B7) and (B8) to verify:
 - How many coffees and cappuccinos have been made.
 - How many times the machine has been descaled.
 - How many cappuccinos have been made;
 - The total number of litres of water delivered.
- Press the ESC icon (B6) once to exit the function or twice to exit the menu.

Buzzer

This activates or deactivates the buzzer emitted by the machine each time an icon is pressed or an accessory is inserted/removed.







N.B.: The buzzer is active by default.

- Press the  icon (B2) to enter the menu and then the   icons (B7) and (B8) until "BUZZER" is displayed.
- Press the OK icon (B9). "BUZZER PLEASE CONFIRM" is displayed.
- Press the ESC (B6) icon (B6) to disable or the OK icon (B9) to enable the buzzer.
- Press the ESC (B6) icon (B6) to exit the menu.

Adjusting contrast

To increase or reduce the contrast of the display, proceed as follows:

- Press the  icon (B2) to enter the menu and then the   icons (B7) and (B8) until "CONTRAST" is displayed.
- Press the OK icon (B9).
- Press the   icons (B7) and (B8) until the required display contrast is reached. The progressive bar indicates the level of contrast selected.
- Press the OK icon (B9) to confirm.
- Press the ESC (B6) icon (B6) once to exit the function or twice to exit the menu.

TURNING THE APPLIANCE OFF

Each time the appliance is turned off, it performs an automatic rinse cycle which cannot be interrupted.



Danger of burns! During rinsing, a little hot water flows from the coffee spouts.

Avoid contact with splashes of water.

To turn the appliance off, press the ON/OFF button (A7).

The appliance performs the rinse cycle then goes off.



N.B.! If the appliance is not used for an extended period, place the main switch on the back of the appliance in the 0 position (A23).

TECHNICAL SPECIFICATION

Voltage: 220-240 V~ 50/60 Hz max. 10A

Absorbed power: 1350 W

Pressure: 15 bars

Water tank capacity: 1.8 litres

Size LxHxD: 594x 455x411 mm

Weight: 23/24 kg



This appliance conforms to EC Regulation 1935/2004 on materials and articles intended

DISPLAYED MESSAGES

DISPLAYED MESSAGE	POSSIBLE CAUSE	REMEDY
FILL TANK!	The water tank is empty or positioned incorrectly.	Fill the tank with water and/or insert it correctly, pushing it as far as it will go.
GROUND TOO FINE ADJUST MILL AND alternating with PRESS OK	The grinding is too fine and the coffee is delivered too slowly.	Turn the grinding adjustment knob one click clockwise towards "7".
GROUND TOO FINE ADJUST MILL AND (alternating with) PRESS OK (then) FILL TANK	The tank has been removed during delivery.	Insert the tank and press the OK icon (B9). "HOT WATER PRESS OK" is displayed. Press the OK icon (B9) again. The appliance is once again ready for use.
EMPTY WASTE COFFEE CONTAINER	The waste coffee container (A4) is too full or more than 3 days have passed since you last made coffee (this guarantees correct hygiene of the machine).	Empty the waste coffee container and clean, then replace. Important: when removing the drip tray, the waste coffee container MUST be emptied, even if it is not completely full. If this is not done, when you make the next coffees, the waste coffee container may fill up more than expected and clog the machine.
INSERT WASTE COFFEE CONTAINER	After cleaning, the waste coffee container has not been replaced.	Open the service door and insert the waste coffee container.
INSERIRE CAFFÈ PRE-MACINATO	The "pre-ground coffee" function has been selected without placing any pre-ground coffee in the funnel. The funnel (A21) is blocked.	Extract the appliance and place pre-ground coffee in the funnel. Empty the funnel with the help of a knife as described in the section "Cleaning the pre-ground coffee funnel".
PLEASE DESCALE!	The machine must be descaled.	The descaling procedure described in the "Descaling" section needs to be performed as soon as possible.
LESS COFFEE	Too much coffee has been used.	Select a milder taste or reduce the quantity of pre-ground coffee, then make the coffee again.
FILL BEAN CONTAINER	The coffee beans have run out.	Fill bean container
INSERT BREWING UNIT	The brewing unit has not been replaced after cleaning.	Insert the brewing unit as described in the section "Cleaning the brewing unit".
CLOSE DOOR	The service door is open	Close the service door.
GENERAL ALARM!	The inside of the appliance is very dirty.	Clean the inside of the appliance thoroughly, as described in the section "Cleaning and maintenance". If the message is still displayed after cleaning, contact a customer services.

TROUBLESHOOTING

Below is a list of some of the possible malfunctions.

If the problem cannot be resolved as described, contact Customer Services.

PROBLEM	POSSIBLE CAUSE	REMEDY
The coffee is not hot	The cups were not preheated. The brewing unit has cooled down because 2/3 minutes have elapsed since the last coffee was made. The temperature set is too low.	Warm the cups by rinsing them with hot water. Before making coffee, preheat the brewing unit by selecting the RINSING function in the menu. Change the set temperature (see paragraph "Changing coffee temperature").
The coffee is not creamy enough	The coffee is ground too coarsely. Wrong type of coffee.	Turn the grinding adjustment knob one click anticlockwise towards "1" while the coffee mill is in operation (fig. 14). Use a type of coffee for espresso coffee makers.
The coffee is delivered too slowly or a drop at a time.	The coffee is ground too finely.	Turn the grinding adjustment knob one click clockwise towards "7" while the coffee mill is in operation (fig. 14). Continue one click at a time until coffee delivery is satisfactory. The effect is only visible after delivering two coffees.
The coffee is delivered too quickly	The coffee is ground too coarsely.	Turn the grinding adjustment knob one click anticlockwise towards "1" while the coffee mill is in operation (fig. 14). Avoid turning the grinding adjustment knob excessively otherwise when you select 2 cups, the coffee may be delivered a drop at a time. The effect is only visible after delivering two coffees.
Coffee does not come out of one of the spouts.	The spouts are blocked.	Clean the spouts with a toothpick (fig. 27).
The coffee does not come out of the spouts, but from around the service door (A2).	The holes in the spouts are clogged with dry coffee dust. The coffee guide (A3) inside the service door is blocked and cannot swing.	If necessary, remove coffee deposits with a toothpick, sponge or stiff bristled kitchen brush (fig. 23). Thoroughly clean the coffee guide (A3), particularly near the hinges.
Water comes out of the spouts instead of coffee.	The pre-ground coffee may be blocked in the funnel (A21).	Clean the funnel (A27) with a wooden or plastic fork, clean the inside of the machine.
The milk does not come out of the milk spout (C5).	The intake tube is not inserted or is inserted incorrectly.	Insert the intake tube (C4) in the rubber washer in the milk container lid (fig. 24).
The milk is not well frothed.	The milk container lid is dirty. The frothed milk regulator is not positioned correctly.	Clean the milk container lid as described in the section "Cleaning the milk container". Adjust following the instructions in the section "Making cappuccino".
The milk contains bubbles or squirts out of the milk spout.	The milk is not cold enough or is not semi-skimmed. The frothed milk regulator is incorrectly adjusted. The milk container lid is dirty.	You should ideally use skimmed or semi-skimmed milk at refrigerator temperature (about 5°C). If the result is still disappointing, try another brand of milk. Move the frothed milk regulator slightly towards the word "CAFFELATTE" (see section "Making cappuccino"). Clean the milk container lid as described in the section "Cleaning the milk container".

RECIPES

Coffee punch

Ingredients (serves 6):

1/2 l of hot coffee
1/2 l of white Port
1/2 l of rum
100 g of candied brown sugar

Method:

Pour the coffee into a pot, add the rum and the Port and heat until it reaches boiling point. Gradually add the candied sugar, tasting now and then until sufficiently sweet. When the sugar has dissolved serve in traditional, short stemmed glasses.

Emperor's coffee

Ingredients (serves 3):

3 espresso coffees
3 egg yolks
3 teaspoons of sugar
3 dl of milk
2 small glasses of brandy

Method:

Beat the egg yolks with the sugar and the brandy. Add hot milk and hot coffee.

RECIPE TIP: lightly whip the milk and add slowly at the very last ingredient.

Best served accompanied by a chocolate cake.

Danish coffee

Ingredients:

6 eggs
grated rind of one lemon
100 g of sugar
3/4 l strong, cold coffee
1 large glass of brandy

Method:

Beat the eggs and the lemon rind, and then add the sugar a little at a time until the eggs become light and airy. Slowly add the coffee and the brandy, stirring constantly. Serve in chilled tea cups or "Ballon" glasses.

Irish coffee

Ingredients (serves 3):

2 spoons of sugar
1 spoon of water
9 teaspoons of whipping cream
6 spoon of Irish Whisky
4 cups of hot coffee

Method:

Boil the water and the sugar for approximately one minute then add to the Whiskey and the hot coffee. Mix and pour into stem glasses. Carefully pour the cream onto the coffee (3 teaspoons per glass).

RECIPE TIP: lightly whip the cream so that it stays on top of the coffee. Grand Marnier or Calvados can also be added.

Coffee sorbet

Ingredients (serves 4):

200 g of granulated sugar
2 dl of espresso coffee

Method:

Combine 1/2 l of water and the sugar to make a syrup and simmer for a few minutes; allow it to cool then mix in the coffee. Filter as soon as a smooth mixture is obtained then place in the freezer to set, mixing often until of a grainy consistency.

Iced coffee

Ingredients:

4 espresso coffees
4 teaspoons of sugar
12 ice cubes

Method:

Crush the ice and add to the pre-sugared coffee. Shake in a shaker until a frothy, creamy mixture is obtained.

RECIPE TIPS: blend on a low blender setting and serve in a flute or glass tumbler.



Küppersbusch

Küppersbusch Hausgeräte GmbH

Postfach 10 01 32, D-45801 Gelsenkirchen,
Küppersbuschstraße 16, D-45883 Gelsenkirchen
Telefon: (0209) 401-0, Telefax: (0209) 401-303
www.kueppersbusch.de

Teka Austria GmbH

Eitnergasse 13, A-1230 Wien
Telefon: (01) 86680-15, Telefax: (01) 86680-50
www.kueppersbusch.at

