

# SIEMENS

EZ8..KZ...

# Full surface induction cooktop



EN Information for Use

Siemens Home Appliances

Register your appliance on My Siemens and  
discover exclusive services and offers.



Further information and explanations are available online:



## Table of contents

1	Safety .....	2
2	Avoiding material damage.....	4
3	Environmental protection and saving energy .....	5
4	Suitable cookware.....	5
5	Familiarising yourself with your appliance .....	7
6	Before using for the first time .....	9
7	Basic operation .....	10
8	Time-setting options.....	11
9	powerBoost .....	12
10	shortBoost.....	13
11	Keep-warm function.....	13
12	flexMotion .....	14
13	cookingSensor .....	14
14	Meal assistant .....	17
15	Wireless cooking sensor .....	17
16	powerMove Pro .....	19
17	Childproof lock.....	20
18	Pause function .....	20
19	Individual safety switch-off .....	20
20	Basic settings.....	20
21	Home Connect .....	21
22	Hob-based hood control.....	23
23	Cleaning and servicing.....	24
24	Troubleshooting.....	25
25	Disposal.....	26
26	Declaration of Conformity .....	27
27	Customer Service.....	28

## 1 Safety

Observe the following safety instructions.

### 1.1 General information

- Read this instruction manual carefully.
- Keep the instructions, the appliance and the product information safe for future reference or for the next owner.
- Do not connect the appliance if it has been damaged in transit.

### 1.2 Intended use

Only a licensed professional may connect appliances without plugs. Damage caused by incorrect connection is not covered under the warranty.

The appliance can only be used safely if it is correctly installed according to the safety instructions. The installer is responsible for ensuring that the appliance works perfectly at its installation location.

Only use this appliance:

- To prepare meals and drinks.
- Under supervision. Never leave the appliance unattended when cooking for short periods.
- in private households and in enclosed spaces in a domestic environment.
- up to an altitude of max. 4000 m above sea level.

Do not use the appliance:

- With an external timer or a separate remote control. This does not apply if operation with appliances included in EN 50615 is switched off.

When using the cooking functions, set the hot-plate on which you have placed the saucepan with the temperature sensor.

If you wear an active implantable medical device (e.g. a pacemaker or defibrillator), check with your doctor that it complies with Council Directive 90/385/EEC of 20th June 1990, EN 45502-2-1 and EN 45502-2-2, and that it has been chosen, implanted and programmed in accordance with VDE-AR-E 2750-10. If these conditions are satisfied, and if, in addition, non-metal cooking utensils and cookware with non-metal handles are used, it is safe to use this induction hob as intended.

### 1.3 Restriction on user group

Do not let children play with the appliance. Children must not perform cleaning or user maintenance unless they are at least 15 years old and are being supervised. Keep children under the age of 8 years away from the appliance and power cable.

### 1.4 Safe use

#### **⚠ WARNING – Risk of fire!**

Leaving fat or oil cooking on an unattended hob can be dangerous and may lead to fires.

- ▶ Never leave hot oil or fat unattended.
- ▶ Never attempt to extinguish a fire using water; instead, switch off the appliance and then cover with a lid or a fire blanket.

The cooking surface becomes very hot.

- ▶ Never place flammable objects on the cooking surface or in its immediate vicinity.
- ▶ Never place objects on the cooking surface.

The appliance will become hot.

- ▶ Do not keep combustible objects or aerosol cans in drawers directly underneath the hob.

Hob covers can cause accidents, for example due to overheating, catching fire or materials shattering.

- ▶ Do not use hob covers.

After every use, switch off the hob using the main switch.

- ▶ Do not wait until the hob turns off automatically as there are no longer any pots and pans on it.

Food may catch fire.

- ▶ The cooking process must be monitored. A short process must be monitored continuously.

#### **⚠ WARNING – Risk of burns!**

The appliance and its parts that can be touched become hot during use, particularly the hob surround, if fitted.

- ▶ Caution should be exercised here in order to avoid touching heating elements.
- ▶ Young children under 8 years of age must be kept away from the appliance.

Hob protective grilles may cause accidents.

- ▶ Never use hob protective grilles.

The appliance becomes hot during operation.

- ▶ Allow the appliance to cool down before cleaning.

Metal objects on the hob quickly become very hot.

- ▶ Never place metal objects (such as knives, forks, spoons and lids) on the hob.

#### **⚠ WARNING – Risk of electric shock!**

Incorrect repairs are dangerous.

- ▶ Repairs to the appliance should only be carried out by trained specialist staff.
- ▶ Only use genuine spare parts when repairing the appliance.
- ▶ If the power cord or the appliance power cable of this appliance is damaged, it must be replaced with a special power cord or special appliance power cable, which is available from the manufacturer or its Customer Service.

If the appliance or the power cord is damaged, this is dangerous.

- ▶ Never operate a damaged appliance.
- ▶ If the surface is cracked, you must switch off the appliance in order to prevent a possible electrical shock. To do this, switch off the appliance via the fuse in the fuse box rather than at the main switch.
- ▶ Never pull on the power cord to unplug the appliance. Always unplug the appliance at the mains.
- ▶ If the appliance or the power cable is damaged, immediately switch off the fuse in the fuse box.

- ▶ Call customer services. → *Page 28*

An ingress of moisture can cause an electric shock.

- ▶ Do not use steam- or high-pressure cleaners to clean the appliance.

The insulation on cables of electrical appliances may melt if it touches hot parts of the appliance.

- ▶ Never bring electrical appliance cables into contact with hot parts of the appliance.

If metallic objects come into contact with the fan that is located on the underside of the hob, this may cause an electric shock.

- ▶ Do not store long, pointed metallic objects in the drawers below the hob.

#### **⚠ WARNING – Risk of injury!**

Saucepans may suddenly jump due to liquid between the saucepan base and the hotplate.

- ▶ Always keep hotplates and saucepan bases dry.
- ▶ Never use icy-cold cookware that has been in the freezer.

The wireless temperature sensor is equipped with a battery, which may become damaged if it is exposed to high temperatures.

- ▶ Remove the sensor from the cookware and store it away from any heat sources.

The temperature sensor may be very hot when removing it from the saucepan.

- ▶ Wear oven gloves or use a tea towel to remove it.

When cooking in a bain marie, the hob and cooking container could shatter due to overheating.

- ▶ The cooking container in the bain marie must not directly touch the bottom of the water-filled pot.
- ▶ Only use heat-resistant cookware.

An appliance with a cracked or broken surface can cause cuts.

- ▶ Do not use the appliance if it has a cracked or broken surface.

### **⚠ WARNING – Danger: Magnetism!**

The wireless temperature sensor is magnetic and can damage electronic implants, e.g. heart pacemakers or insulin pumps.

- ▶ Persons with electronic implants must stand at least 10 cm away from the magnetic control element.
- ▶ Never put the control element in your pockets.

### **⚠ WARNING – Risk of suffocation!**

Children may put packaging material over their heads or wrap themselves up in it and suffocate.

- ▶ Keep packaging material away from children.
- ▶ Do not let children play with packaging material.

Children may breathe in or swallow small parts, causing them to suffocate.

- ▶ Keep small parts away from children.
- ▶ Do not let children play with small parts.

## **2 Avoiding material damage**

This is where you can find the most common causes of damage and tips on how to avoid them.

<b>Damage</b>	<b>Cause</b>	<b>Measure</b>
Stains	Unsupervised cooking process.	Monitor the cooking process.
Stains, blisters	Spilled food, especially food with a high sugar content.	Remove immediately with a glass scraper.
Stains, blisters or fractures in the glass	Defective cookware, cookware with melted enamel or cookware with copper or aluminium base.	Use suitable cookware that is in a good condition.
Stains, discolouration	Unsuitable cleaning methods.	Only use cleaning agents that are suitable for glass ceramic, and only clean the hob when it is cold.
Blisters or fractures in the glass	Knocks or falling cookware, cooking accessories or other hard or pointed objects.	When cooking, do not hit the glass or let objects fall onto the hob.
Scratches, discolouration	Rough cookware bases or moving the cookware on the hob.	Check the cookware. Lift the cookware when moving it.
Scratches	Salt, sugar or sand.	Do not use the hob as a work surface or storage space.
Damage to the appliance	Cooking with frozen cookware.	Never use frozen cookware.
Damage to the appliance	Hot cookware on the control panel, the display panels or the hob frame.	Never place hot cookware on these areas.
Damage to the cookware or the appliance	Cooking without contents.	Never place or heat empty cookware on a hot cooking zone.
Glass damage	Melted material on the hot cooking zone or hot pot lid on the glass.	Do not place greaseproof paper or aluminium foil nor plastic containers or pot lids on the hob.
Overheating	Hot cookware on the control panel or on the frame.	Never place hot cookware on these areas.

**ATTENTION!**

A fan is located on the underside of this hob.

- ▶ If a drawer is located on the underside of the hob, do not store any small or pointed objects, paper or tea towels in it. These objects may be sucked in and damage the fan or impair the cooling.
- ▶ There must be a clearance of at least 2 cm between the contents of the drawer and the fan entry point.

## 3 Environmental protection and saving energy

### 3.1 Disposing of packaging

The packaging materials are environmentally compatible and can be recycled.

- ▶ Sort the individual components by type and dispose of them separately.

### 3.2 Saving energy

If you follow these instructions, your appliance will use less energy.

Select the cooking zone to match the size of your pan. Centre the cookware on the hob.

Always place items of cookware inside the usable area of the cooking surface.

**Tip:** Cookware manufacturers often give the upper diameter of the saucepan. It is often larger than the base diameter.

- Unsuitable cookware or incompletely covered cooking zones consume a lot of energy.

Cover saucepans with suitable lids.

- Cooking without a lid consumes considerably more energy.

Lift lids as infrequently as possible.

- When you lift the lid, a lot of energy escapes.

Use a glass lid.

- You can see into the pan through a glass lid without having to lift it.

Use pots and pans with flat bases.

- Uneven bases increase energy consumption.

Use cookware that is suitable for the quantity of food.

- Large items of cookware containing little food need more energy to heat up.

Cook with only a little water.

- The more water that is contained in the cookware, the more energy is required to heat it up.

Turn down to a lower power level early on.

- If you use an ongoing power level that is too high, you will waste energy.

Product Information according (EU) 66/2014 can be found on the attached appliance pass and online on the product page for your appliance.



## 4 Suitable cookware

Cookware that is suitable for induction cooking must have a ferromagnetic base. This means that the cookware must be magnetic and be the recommended size. The hob uses the ferromagnetic diameter and material of the base of the cookware to automatically detect the position, size and shape of the cookware being used. Follow the cookware manufacturer's instructions.

Cookware with a base measuring 90 to 340 mm in diameter is suitable for use.

### 4.1 Size and characteristics of the cookware

To be able correctly detect the cookware, you must take the size and the material of the cookware into consideration. All cookware bases must be perfectly flat and smooth.

Cookware	Materials	Properties
Recommended cookware	Stainless steel cookware in a sandwich design that distributes the heat well.	This cookware distributes the heat evenly, heats up quickly, and ensures that it can be detected easily.
	Ferromagnetic cookware made of enamelled steel, cast iron or special induction cookware made of stainless steel.	This cookware distributes the heat evenly, heats up quickly, and ensures that it can be detected.
Suitable	The base is not fully ferromagnetic.	If the ferromagnetic area is smaller than the base of the cookware, only the area that is ferromagnetic heats up. As a result, the heat is not distributed evenly.
		



---

Cookware bases that contain aluminium.

These cookware bases reduce the ferromagnetic area, which means that less power is emitted to the cookware. This cookware may not be sufficiently detected or may not be detected at all, and therefore does not heat sufficiently.

---

Not suitable

Cookware made from normal thin steel, glass, clay, copper or aluminium.

---

**Notes**

- Do not use adapter plates between the hob and the cookware.
- Do not heat up empty cookware and do not use cookware with a thin base, as this may become very hot.

## 5 Familiarising yourself with your appliance

### 5.1 Cooking surface

The entire cooking surface of the hob supplies induction heating. Place the cookware on any position within the limits of the usable cooking surface. The hob automatically detects the position, size and shape of the cookware.

You can cook with up to five items of cookware on the cooking surface at the same time.

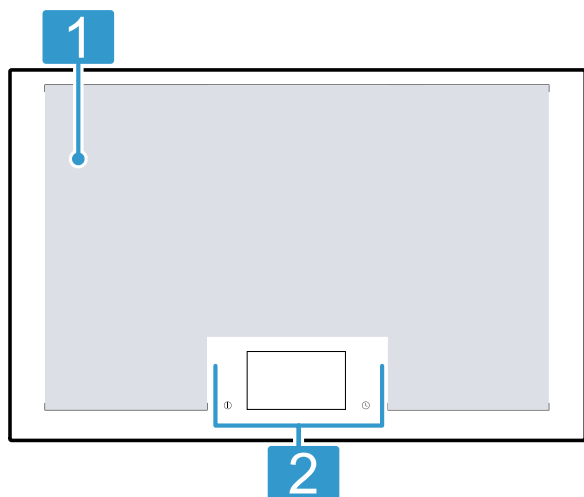

**1** Usable cooking surface

**2** Control panel

### 5.2 Control panel

Individual details, such as colour and shape, may differ from the figure.



#### Notes

- Always keep the control panel clean and dry.
- Do not place any cookware near the displays or buttons. The electronics may overheat.

#### Touch buttons

When you switch on the hob, the symbols for the controls available at this time light up.

Button	Function
ⓘ	Main switch
	Pause function

Button	Function
^	Docking menu <ul style="list-style-type: none"> <li>Info menu</li> <li>Childproof lock</li> <li>Basic settings</li> </ul>
🕒	countUp function
🔔	Timer
⚙️	powerMove Pro
	Cooking modes menu <ul style="list-style-type: none"> <li>Power levels</li> <li>powerMove Pro</li> <li>cookingSensor</li> <li>Meal assistant</li> </ul>
	Hotplate <ul style="list-style-type: none"> <li>1...9 power levels</li> <li>powerBoost</li> <li>shortBoost</li> <li>Keep-warm function</li> <li>Switch-off timer</li> </ul>

### Buttons in connection with Home Connect

As soon as the connection to Home Connect has been established, the following buttons are available:

Button	Function
📶	Connectivity
🔗	cookConnect System
🌬️	Ventilation control sensor
💡	Hood lighting

### 5.3 Touch display

You can use the touch display to operate the appliance simply and intuitively.

#### Main screen

It shows the cookware on the cooking surface and the current settings for the active cooking zone, e.g. cooking mode, power levels and active time-setting options.

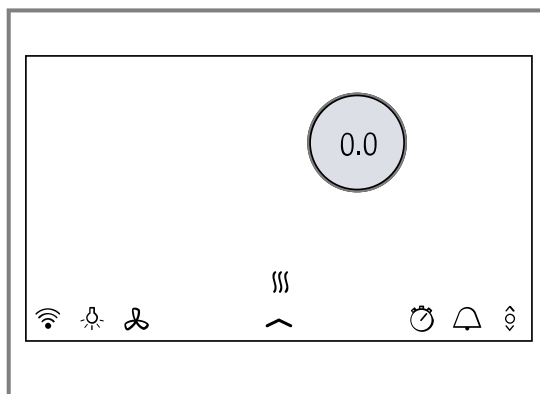

#### Settings range

Go to the settings area for a particular cooking zone if you want to configure the heat settings, cooking times or the various cooking modes for this cooking zone.

You can select the required cooking zone by touching the corresponding display. The settings area for the cooking zone that you have selected appears in the display panel.

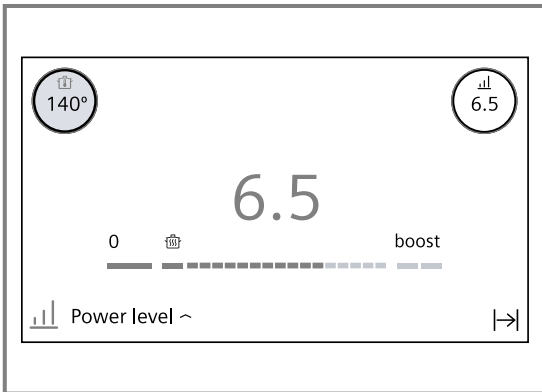

### Status bar

Enables access to certain functions and additional menus.

The status bar shows the following options:

	Connectivity
	Hood lighting
	cookConnect System
	Docking menu
	countUp function
	Basic settings
	powerMove Pro

### Docking menu

Enables access to certain functions and additional menus.

### Opening the docking menu

1. In the lower area of the main screen, touch and swipe up.

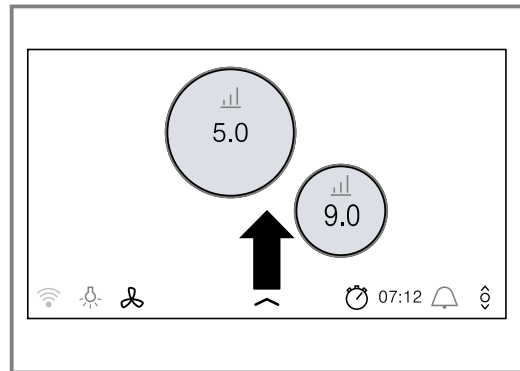

The docking menu contains the following functions:

	Info menu
	Childproof lock
	Basic settings

2. To exit the docking menu, touch and swipe down.

### Info menu

You can call up information about the appliance and the current functions.

#### Opening the info menu

1. Open the docking menu.
2. Touch .
- ✓ The available options are displayed.
3. To return to the main view, touch .

**Note:** You can also access information about the functions you are currently using. To do this, touch the symbol for the function you require and hold it for a few seconds. On the display, an info window appears that describes the current function.

### Notifications and instructions

These help you to operate the appliance correctly. The display shows information about a change in the appliance's status or notifies the user when they need to do something.

Follow the instructions in the display panel.

### Cooking modes menu

The hob has a number of different cooking modes.



To access them, set the active cooking mode in the programming area of the selected cooking zone.



Symbol	Cooking mode	Function
	Power levels	Allows you to select the power level for each item of cookware.
	powerMove Pro	The temperature can be adjusted via the position of the cookware on the cooking surface.
	cookingSensor	The wireless cooking sensor automatically detects the temperature as cooking progresses. Available after connection to the wireless cooking sensor.
	Meal assistant	Frying and cooking with preselected settings for particular dishes.



## 5.4 Cooking zone displays

When you place an item of cookware on the cooking surface, the indicator for the relevant cooking zone lights up in the touch display.

Hotplate	Status
	<b>Detected cooking zone</b> <ul style="list-style-type: none"> <li>The cookware on the cooking surface has been detected.</li> <li>The cooking zone display lights up.</li> <li>Touch the display to select the cooking zone.</li> </ul>
	<b>Selected cooking zone</b> <ul style="list-style-type: none"> <li>The displayed cooking zone has been selected.</li> <li>You can set the power level.</li> </ul>
	<b>Cooking zone that is switched on</b> <ul style="list-style-type: none"> <li>The displayed cooking zone is switched on.</li> <li>The selected power level lights up on the display.</li> </ul>

Hotplate	Status
	<b>No cookware on the cooking zone</b> <ul style="list-style-type: none"> <li>You have removed the cookware from the cooking surface.</li> <li>The previously selected power level changes colour.</li> </ul>
	<b>Other displays</b> <ul style="list-style-type: none"> <li>You cannot set the selected cooking zone.</li> <li>For more information, touch .</li> </ul> Possible causes: <ul style="list-style-type: none"> <li>Up to five items of cookware evenly distributed over the cooking surface can be heated at the same time.</li> <li>The cookware is not suitable for use on an induction hob.</li> <li>The appliance has exceeded its maximum power consumption.</li> </ul>

**Note:** The cooking zone displays may show a different size or shape to the cookware actually being used. This is normal and does not affect the functioning of the hob.

## 5.5 Residual heat indicator

The cooking surface has two residual heat indicators that indicate that the cooking zone is still hot.

- The  symbol in the main screen. One, two or all three lines light up depending on the intensity of the residual heat.

Do not touch the cooking surface while the residual heat indicators are still lit or immediately after they have gone out.

The residual heat indicators will remain lit for as long as the cooking surface is still hot, even if you switch off the cooking surface.

# 6 Before using for the first time

Observe the following recommendations.

## 6.1 Initial cleaning

Remove any leftover packaging from the hob surface and wipe the surface with a damp cloth. You can find a list of recommended detergents on the official website [siemens-home.bsh-group.com](http://siemens-home.bsh-group.com).

More information on care and cleaning. → *Page 24*

## 6.2 Cooking with induction

In comparison to conventional hobs, induction technology brings with it a series of changes and has a number of benefits such as time savings when cooking and frying, energy savings as well as greater ease of cleaning and care. It also offers improved heat control as the heat is generated directly in the cookware.

## 6.3 Cookware

You can find a list of recommended cookware on the official website [siemens-home.bsh-group.com](http://siemens-home.bsh-group.com). Further information on suitable cookware.

## 6.4 Initial start-up

When you switch on the appliance for the first time, the standard language setting appears on the display as a first step to configure the hob.

You can change these settings at any time in the basic settings. → *Page 20*

## 6.5 Setting Home Connect

To start the connection settings, select the Home Connect setting in the basic settings and follow the instructions in the section entitled → *"Home Connect", Page 21.*

## 7 Basic operation

### 7.1 Switching the hob on

- ▶ Touch .
  - A signal tone sounds and the touch display lights up.
- ✓ The hob is ready to use.

#### reStart

- ▶ If you switch the appliance on within 10 seconds of switching it off, the hob operates with the settings that were previously set. You can activate this function in the basic settings. → Page 20

### 7.2 Switching the hob off

- ▶ Touch  until the displays go out.
- ✓ All cooking zones are switched off.

**Note:** If all of the cooking zones are switched off for longer than 30 seconds, the hob is automatically switched off.

### 7.3 Setting the power level in the cooking zones

The cooking zone has 17 power levels, which are displayed from 1 to 9 with intermediate values. Select the best power level for the food and the planned cooking process.

**Requirement:** The hob must be switched on.

1. Place the cookware on the cooking surface.
  2. Touch the required cooking zone display.
- ✓ The settings area for the cooking zone that you have selected appears on the display.

### 7.4 Cooking tips

- When heating up puree, cream soups or thick sauces, stir occasionally.
- To preheat, set the power level 8-9.
- When cooking with the lid on, reduce the power level as soon as you see steam escaping. The cooking result is not affected by the steam escaping.
- After cooking, place a lid on the cookware until you serve the dish.
- To cook with the pressure cooker, observe the manufacturer's instructions.
- Do not cook food for too long, otherwise nutrients will be lost. The kitchen timer enables you to set the optimal cooking time.
- Ensure that the oil does not smoke.
- To brown the food, fry it in small portions, one after the other.
- Some items of cookware may reach high temperatures while the food is cooking. You should therefore use oven gloves.
- You can find recommendations for energy-efficient cooking under → "Saving energy", Page 5

3. Swipe your finger over the settings area and touch the power level that you require.
- ✓ The power level has been set.

#### quickStart

- ▶ If you place cookware on the cooking surface before you switch on the appliance, it is detected when the main switch is pressed and the cooking zone display appears on the touchscreen.

### Changing the power level and switching off the cooking zone

1. Select the cooking zone.
  2. Select the required power level or set it to 0 in the settings area.
- ✓ The cooking zone's power level changes or the cooking zone switches itself off and the residual heat indicator appears.

### No cookware/cookware of an unsuitable size



**Requirement:** Always place items of cookware inside the usable area of the cooking surface.



- ▶ If the cookware is not positioned correctly or is not the right material or the right size,  is displayed next to the cooking zone display. Move the cookware or use different cookware. If you remove the active cookware from the cooking surface for more than 30 seconds, the hotplate automatically switches off.

### Switching off the cooking zone quickly

- ▶ If you press and hold the cooking zone display on the main display for a few seconds, the power level is set automatically to 0.0. You can switch this function off in the basic settings. → Page 20

### Cooking recommendations

The table shows which power level () is suitable for which food. The cooking time ( min) may vary depending on the type, weight, thickness and quality of the food.

		 min
<b>Melting</b>		
Chocolate coating	1 - 1.5	-
Butter, honey, gelatine	1 - 2	-
<b>Heating and keeping warm</b>		
Stew, e.g. lentil stew	1.5 - 2	-
Milk <sup>1</sup>	1.5 - 2.5	-
Boiled sausages <sup>1</sup>	3 - 4	-
<b>Defrosting and heating</b>		
Spinach, frozen	3 - 4	15 - 25
Goulash, frozen	3 - 4	35 - 55
<b>Poaching, simmering</b>		
Potato dumplings <sup>1</sup>	4.5 - 5.5	20 - 30

<sup>1</sup> Without lid

		⌚ min
Fish <sup>1</sup>	4 - 5	10 - 15
White sauces, e.g. Béchamel sauce	1 - 2	3 - 6
Whisked sauces, e.g. Béarnaise sauce, Hollandaise sauce	3 - 4	8 - 12
<b>Boiling, steaming, braising</b>		
Rice, with double the volume of water	2.5 - 3.5	15 - 30
Rice pudding	2 - 3	30 - 40
Unpeeled boiled pots	4.5 - 5.5	25 - 35
Boiled potatoes	4.5 - 5.5	15 - 30
Pasta <sup>1</sup>	6 - 7	6 - 10
Stew	3.5 - 4.5	120 - 180
Soups	3.5 - 4.5	15 - 60
Vegetables	2.5 - 3.5	10 - 20
Vegetables, frozen	3.5 - 4.5	7 - 20
Stew in a pressure cooker	4.5 - 5.5	-
<b>Stewing</b>		
Rolled roasting joint	4 - 5	50 - 65
Pot roast	4 - 5	60 - 100
Goulash	3 - 4	50 - 60
<b>Braising/frying with a small amount of fat <sup>1</sup></b>		
Escalope, plain or breaded	6 - 7	6 - 10
Escalope, frozen	6 - 7	6 - 12
Chops, plain or breaded	6 - 7	8 - 12
Steak (3 cm thick)	7 - 8	8 - 12
Poultry breast (2 cm thick)	5 - 6	10 - 20

<sup>1</sup> Without lid

		⌚ min
Poultry breast, frozen	5 - 6	10 - 30
Rissoles (3 cm thick)	4.5 - 5.5	20 - 30
Hamburgers (2 cm thick)	6 - 7	10 - 20
Fish and fish fillet, plain	5 - 6	8 - 20
Fish and fish fillet, breaded	6 - 7	8 - 20
Fish, breaded and frozen, e.g. fish fingers	6 - 7	8 - 15
Prawns and scampi	7 - 8	4 - 10
Sautéing fresh vegetables and mushrooms	7 - 8	10 - 20
Stir-fry, vegetables, meat cut in strips Asian-style	7 - 8	15 - 20
Frozen dishes, e.g. stir-fries	6 - 7	6 - 10
Pancakes, cooked one after the other	6.5 - 7.5	-
Omelette (cooked one after the other)	3.5 - 4.5	3 - 10
Fried eggs	5 - 6	3 - 6
<b>Deep-frying, 150–200 g per portion in 1–2 l oil, deep-fat fried in portions <sup>1</sup></b>		
Frozen products, e.g. chips, chicken nuggets	8 - 9	-
Croquettes, frozen	7 - 8	-
Meat, e.g. chicken portions	6 - 7	-
Fish, breaded or battered	6 - 7	-
Vegetables, mushrooms, breaded, beer-battered or tempura	6 - 7	-
Small baked items, e.g. doughnuts, battered fruit	4 - 5	-

<sup>1</sup> Without lid

## 8 Time-setting options

Your hob has various functions for setting the cooking time:

- Switch-off timer
- Timer
- countUp function

### 8.1 Switch-off timer

You can use this function to programme a cooking time for one or more cooking zones. The cooking zone is automatically switched off once the time that is set has elapsed.

You can set a cooking time of up to 12 hours 59 minutes.

#### Switching on Switch-off timer

1. Select the cooking zone and the power level.
2. Touch  in the settings area.
3. Set the cooking time in the settings area.
  - To set the number of hours, touch 00 h and select the time in the settings area.

- To set the number of minutes, touch 00 min and select the time in the settings area.





You can set the minutes in 30-second increments up to 5 minutes. The seconds appear above the minutes display.

#### 4. Touch to confirm.

- ✓ The cooking time begins to elapse.
- ✓ Once the cooking time has elapsed, the cooking zone is switched off and a signal sounds.

**Note:** When you set a cooking time for a cooking zone in which the cookingSensor is activated, the cooking time will not start counting down until the selected temperature level has been reached.

#### Changing or switching off Switch-off timer

1. Select the cooking zone and touch .
2. Change the cooking time in the programming area or touch  to delete the time.
3. Touch  to confirm the selected setting.
4. Touch  to return to the main view.

## 8.2 Timer

You can use this function to switch on a timer. This function operates independently of the cooking zones and other settings. It does not automatically switch off the cooking zones.

### Setting the kitchen timer



1. Press .
2. Set the required time.
  - To set the number of hours, touch 00 h and select the time in the settings area.
  - To set the number of minutes, touch 00 min and select the time in the settings area.

You can set the minutes in 30-second increments up to 5 minutes. The seconds appear above the minutes display.

3. Press .
- ✓ The cooking time begins to elapse.
  - ✓ After a few seconds, the time appears in the main view.
  - ✓ When the time has elapsed, a signal sounds.
  - ✓ The time display shows 00:00.

4. Touch .
  - ✓ The displays go out
  - ✓ The signal stops.

### Changing or deleting the short-term timer

1. Touch .
2. Change the set time.
3. Touch to confirm the setting.
4. Touch  to delete the time.





## 8.3 countUp function

The stopwatch function displays the time that has elapsed since activation.

### Switching on countUp function

- ▶ Touch .
- ✓ The time starts to elapse.

### Switching off countUp function

1. Touch .
2. Touch . The time display is set to 00 m 00 s. To switch the time display on again, touch .
3. To return to the main view, touch .

# 9 powerBoost

This function allows large volumes of water to be heated up even more quickly than with power level 9. The function can be selected when the option boost is displayed in the settings area for the cookware. The function is only available for one item of cookware on each side of the cooking surface.

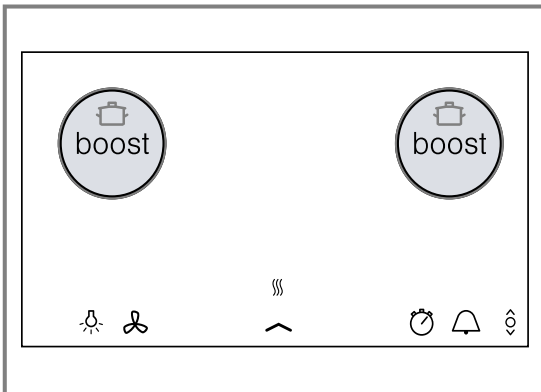

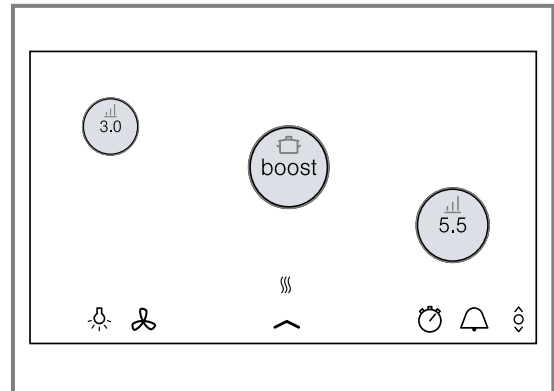

If the function is activated and you select a second cooking zone on the same side of the cooking surface, the appliance deactivates the function. The appliance automatically sets power level 9.0.



If the function is activated in the centre of the cooking surface, you can change the settings for other cookware on the right- and left-hand sides of the hob.

### 9.1 Switching on powerBoost

1. Select the cooking zone.
2. Select boost in the settings area.
  - ✓  and  light up.
3. Touch .
- ✓ The function is switched on.

### 9.2 Switching off powerBoost

1. Select the cooking zone.
2. Set a different power level in the settings area.
  - ✓ The function is switched off.

**Note:** In certain circumstances, this function may powerBoost switch off automatically in order to protect the electronics components on the circuit board inside.

## 10 shortBoost

You can use this function to heat up the cookware faster than with power level 9.0.

After deactivating the function, select the appropriate ongoing cooking setting for your food.

The function can be selected when the option boost is displayed in the settings area for the cookware. The function is only available for one item of cookware on each side of the cooking surface.

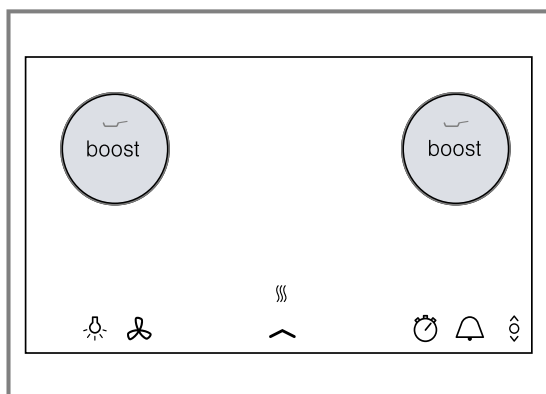

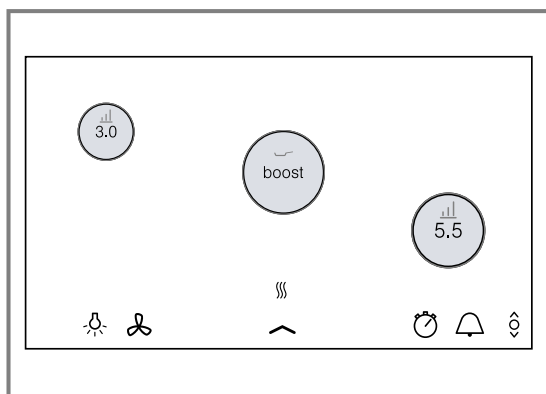

If you select settings for a different cooking zone on the same side of the cooking surface, the booster function is deactivated. The power level 9.0 is set automatically. If the function is activated in the centre of the cooking surface, you can implement the settings for other cookware on the right- and left-hand sides of the hob.



### 10.1 Recommended applications

- Only use cold cookware.
- Use cookware with a completely flat base. Do not use cookware with a thin base.
- Never heat up empty cookware or oil, butter or lard unattended.
- Do not place a lid on the cookware.
- You can find information on the type, size and positioning of the cookware in the Suitable cookware section. → Page 5

### 10.2 Switching on shortBoost

1. Select the cooking zone.
2. Select Boost in the settings area.
3.  and  light up.
4. Press .

### 10.3 Switching off shortBoost

- ▶ Touch the cooking zone display and select any power level in the settings area.

**Note:** The shortBoost function automatically switches off after 30 seconds and then automatically switches to power level 9.0.

## 11 Keep-warm function

You can use this function to melt chocolate or butter, and to keep meals warm.

### 11.1 Switching on Keep-warm function

1. Select the cooking zone.
2. Select the lowest power level in the settings area.
  - ✓  lights up.
  - ✓ The function is switched on.

### 11.2 Switching off Keep-warm function

1. Select the cooking zone.
2. Select a different power level in the settings area.
  - ✓  goes out.
3. The function is switched off.

## 12 flexMotion

You can use this function to transfer the set power level or temperature level and the cooking time when you move the cookware on the cooking surface. If you remove the cookware from the cooking surface or move it, the cooking zone no longer heats up. The settings for the cooking zone are retained for 30 seconds. When you place the cookware back in this position, the same settings are used.

### 12.1 flexMotion

1. Place the cookware down at a different position on the cooking surface.

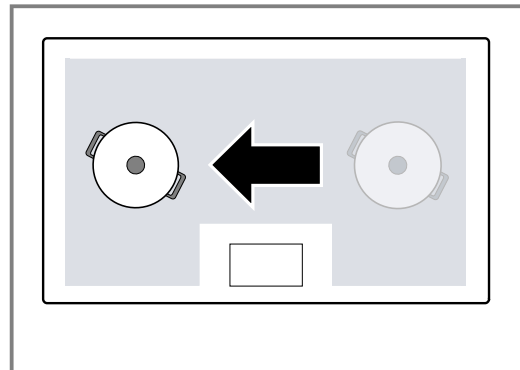

- ✓ The cooking zone display shows the new position of the cookware with the power level.
  - ✓ A message appears on the display.
2. Confirm the transfer of settings.
- ✓ The settings are transferred to the new cooking zone.

## 13 cookingSensor

You can use this function to heat up, cook or boil foods, cook with the pressure cooker or fry in a pot with a lot of oil at a controlled temperature. In order to use these functions, you need the wireless cooking sensor for wireless cooking. This function is available for all cooking zones with the wireless cooking sensor on the normal cookware.

### 13.1 Temperature levels

Temperature levels for preparing meals.

Level	Temperature	Functions	Cookware
1	70 °C	Heating and keeping warm	
2	85 °C	Poaching in milk	
3	90 °C	Poaching in water	
4	100 °C	Boiling	
5	115 °C	Cooking in a pressure cooker	
6	160 °C	Deep-fat frying in an immersion bath at a low temperature	

Level	Temperature	Functions	Cookware
7	170 °C	Deep-fat frying in an immersion bath at a medium temperature	
8	180 °C	Deep-fat frying in an immersion bath at a high temperature	



### 13.2 Notes on the cookingSensor function

- The wireless cooking sensor measures the temperature of the liquid through the silicone base attached to the container. To ensure correct measurement, the silicone base must be completely covered by the liquid to be measured.
- The frame of the wireless cooking sensor and the silicone base fitted on the cookware must be completely dry before you can start cooking.
- Do not remove the wireless cooking sensor during cooking. After cooking, remove the sensor carefully as the sensor may be hot.
- To save energy, use a lid.
- Position the cookware in such a way that the wireless cooking sensor is pointing towards the outer side of the hob.
- To prevent overheating, never align the cooking sensor to any other hot cookware.

### 13.3 Switching on cookingSensor

**Requirement:** Connect the wireless cooking sensor.

1. Attach the wireless cooking sensor to the cookware.

2. Place cookware filled with sufficient liquid on the required cooking zone and put the lid on.
3. Select the cooking zone on which you have placed the cookware with the wireless cooking sensor.
4. Touch the active cooking mode and select the  cookingSensor option.
5. Then touch the centre of the wireless cooking sensor.
6. Select the corresponding temperature level for the food you want to cook.
  - ✓ The function is switched on.
  - ✓ The temperature level and  light up. The temperature display lights up increasingly red until the water or oil has reached the appropriate temperature for adding the food for cooking. A signal sounds.
7. Once the signal tone has sounded, remove the lid and add the food. Cook with the lid on.

### 13.4 Switching off cookingSensor

1. Select the cooking zone.
2. Set to 0.
  - ✓ The function is switched off.
3. To exit the cookingSensor function, select a different cooking mode.

### 13.5 Recommendations for cooking with cookingSensor

The following table shows the ideal temperature levels for a selection of dishes. ™ °C and ☹ min depend on the amount, condition and quality of the food.

#### Heating and keeping warm

	™ °C	☹ min
Heating goulash	70	10-20
Heating mulled wine	70	5-15
Vegetables in cream sauce	70	15-20
Defrosting broths	70	15-25

#### - Poaching in milk

	™ °C	☹ min
<b>Potatoes</b>		
Potato dumplings	85	30-40
<b>Pasta and cereals</b>		
Polenta	85	3-8
Semolina pudding	85	5-10
<b>Desserts</b>		
Rice pudding	85	40-50
Porridge	85	10-15
Chocolate pudding	85	3-5
<b>Other</b>		
Heating milk	85	3-10

#### Poaching in water.

	™ °C	☹ min
<b>Meat</b>		
Sausages	90	10-20
<b>Fish</b>		

	™ °C	☹ min
Braised fish	90	15-20

#### **Pasta and cereals**

Rice	90	25-35
Parboiled rice	90	25-35
Brown rice	90	45-55
Exotic rice dishes (Basmati, Thai)	90	8-12
Wild rice	90	20-30
Quinoa	90	10-12

#### **Soups**

Instant creams	90	10-15
----------------	----	-------

#### - Bringing to the boil

	™ °C	☹ min
--	------	-------

#### **Meat**

Meatballs	100	20-30
Chicken	100	60-90
Veal	100	60-90

#### **Egg dishes**

Boiled eggs	100	5-10
-------------	-----	------

#### **Vegetables and legumes**

Broccoli	100	10-20
Cauliflower	100	10-20
Spinach	100	5-10
Brussels sprouts	100	30-40
Green beans	100	15-30
Chickpeas	100	60-90
Peas	100	15-20
Lentils	100	45-60

#### **Potatoes**

Gnocchi	100	3-6
Potatoes, boiled	100	30-45
Sweet potatoes	100	30-45

#### **Pasta and cereals**

Durum wheat pasta	100	7-10
Fresh pasta	100	3-5
Wholemeal pasta	100	7-10
Durum wheat pasta, stuffed	100	15-20
Fresh pasta, stuffed	100	5-8
Quinoa	100	10-12

#### **Soups**

Home-made broths	100	60-90
Instant soups	100	5-10

#### **Desserts**

Compote	100	15-25
---------	-----	-------

#### **Frozen products**

Green beans	100	15-30
-------------	-----	-------

### Cooking in a pressure cooker

	⌘ °C	⌚ min
<b>Meat</b>		
Chicken	115	15-25
Veal	115	15-25
<b>Vegetables and legumes</b>		
Vegetables	115	3-6
Chickpeas	115	25-35
Lentils	115	10-20
Beans	115	25-35
<b>Potatoes</b>		
Potatoes	115	10-20
Sweet potatoes	115	10-20
<b>Pasta and cereals</b>		
Rice	115	6-8
Brown rice	115	12-18
<b>Soups</b>		
Home-made broths	115	20-30

### Deep-fry with a large amount of oil at a low temperature.

Use the lid to heat the oil, and remove it to fry the food.

	⌘ °C	⌚ min
<b>Potatoes</b>		
Patatas bravas	160	8-12
<b>Desserts</b>		
Jam-filled doughnuts and doughnuts	160	5-10

### Deep-fry with a large amount of oil at a medium temperature.

Use the lid to heat the oil, and remove it to fry the food.

	⌘ °C	⌚ min
<b>Meat</b>		
Chicken pieces	170	10-15
Meatballs	170	10-15
<b>Fish</b>		
Fish, beer-battered or breaded	170	10-15
<b>Vegetables and legumes</b>		
Vegetables, beer-battered or breaded	170	4-8
Mushrooms, breaded or beer-battered	170	4-8

### Deep-fry with a large amount of oil at a high temperature.

Use the lid to heat the oil, and remove it to fry the food.

	⌘ °C	⌚ min
<b>Frozen products</b>		
Chips	180	4-8

## 13.6 Wireless cooking sensor

To use cookingSensor, you must purchase a wireless cooking sensor.

You can purchase the wireless cooking sensor from customer service, in our online shop or in a specialist shop [siemens-home.bsh-group.com](http://siemens-home.bsh-group.com).

### Connecting the wireless cooking sensor

To connect the wireless cooking sensor to the control panel, proceed as follows:

1. Open the docking menu.
2. Open the basic settings and select the "Cooking sensor" menu item.
3. Select the "Add a new cooking sensor" option.
4. Briefly touch the centre of the wireless cooking sensor within 30 seconds.
  - After a few seconds, the result of the connection between the cooking sensor and the control panel appears on the display.

#### Result

✔ Connected correctly	cookingSensor is available.
! Not connected correctly	Communication error <ul style="list-style-type: none"> <li>▪ Repeat the connection process. If the result is still !, contact customer service.</li> </ul>
⚠ Not connected correctly	Communication error <ul style="list-style-type: none"> <li>▪ Bluetooth communication error. Repeat the connection process.</li> <li>▪ You have not touched the centre of the wireless cooking sensor within 30 seconds of selecting the cooking zone. Repeat the connection process.</li> <li>▪ The battery in the wireless cooking sensor is flat. Replace the battery, reset the wireless cooking sensor and repeat the connection process.</li> </ul>

- ✓ Once the cooking sensor has been connected to the control panel correctly, the cooking sensor is available.

### Resetting the wireless cooking sensor

1. Press the centre of the cooking sensor for approx. 8 - 10 seconds.
  - ✓ During this process, the LED display for the wireless cooking sensor lights up three times.
  - ✓ When the LED lights up for the third time, it will start to reset the temperature sensor.
2. Now stop pressing the centre of the wireless cooking sensor.
  - ✓ As soon as the LED goes out, this means that the wireless cooking sensor has been reset.
3. Repeat the connection process from point 2.

### Setting the boiling point

The point at which water starts to boil depends on the height of your home above sea level. If the water is boiling too vigorously or not vigorously enough, you can adjust the boiling point. Proceed as follows:

Select the "Set boiling point" setting in the basic settings. → Page 20

The default basic setting is 200–400 m. If your home is located at this height above sea level, do not set the boiling point. Select the setting that matches your home's height above sea level.



**Note:** Temperature 4/100 °C is sufficient to boil efficiently. For a more intensive boil, select a lower level.

**Tip:** If you want to set the temperature more precisely, you can increase or decrease this by 1 °C to 5 °C. To do this, touch the selected temperature and then select + / -. Then select the required temperature. To cancel and exit the menu, touch the symbol.

## 14 Meal assistant

All types of food can be prepared with this function. The appliance selects the optimal setting for you. The recipes for the cookingSensor function are only available after connecting to the wireless cooking sensor.

### 14.1 Activating the meal assistant

1. Select a cooking zone.
2. Touch the active cooking mode and select .

3. Select the required programme group and food.
4. Follow the instructions on the display.

### 14.2 Cancelling the meal assistant

1. Select the cooking zone.
  2. Select the active cooking mode and switch to a different cooking mode.
- ✓ The function is switched off.

## 15 Wireless cooking sensor

To use cookingSensor, you must purchase a wireless cooking sensor.

You can purchase the wireless cooking sensor from customer service, in our online shop or in a specialist shop [siemens-home.bsh-group.com](http://siemens-home.bsh-group.com).

### 15.1 Scope of delivery

After unpacking all of the parts, check for any transport damage and for completeness of delivery.

- **A** Wireless cooking sensor
- **B** Silicone patch
- **C** Template

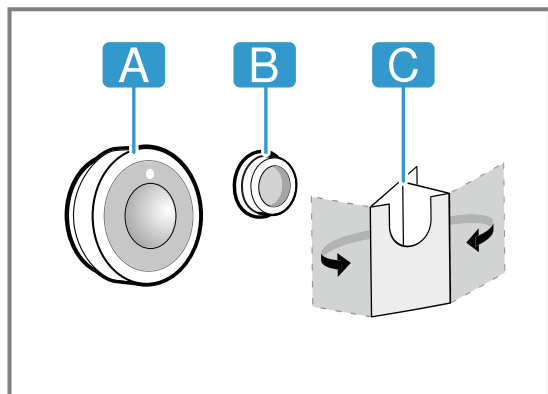

### 15.2 Attaching the silicone patch

The silicone patch secures the cooking sensor to the cookware. For fitting on the cookware:

1. The adhesive area on the cookware must be free from grease. Clean and dry the container thoroughly, and rub the adhesive area using alcohol, for example.

2. Remove the protective film from the silicone patch. Adhere the silicone patch to the outside of the cookware in the correct place using the enclosed template as a guide.

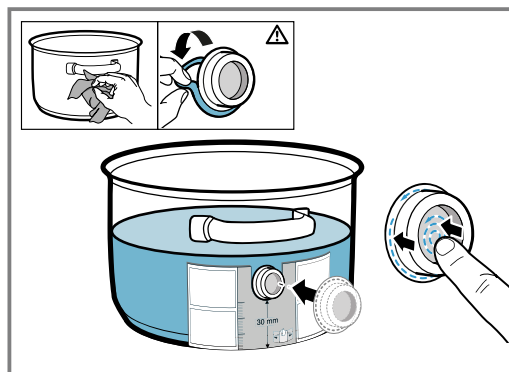

3. Press down all over the surface of the silicone patch, including in the centre.
4. Leave the adhesive to dry for one hour. Do not use or rinse out the cookware during this time.

**Note:** If the silicone patch comes loose, use a new one. If required, you can purchase a set with five silicone patches from specialist retailers, from our customer service or on our official website [siemens-home.bsh-group.com](http://siemens-home.bsh-group.com) by quoting the article number 17007119.

All adhesives break down over time when they are stored. To prevent this from happening, place the silicone bases on their containers as soon as they are cleaned.

### 15.3 Attaching the wireless cooking sensor

1. Ensure that the silicone patch is completely dry before attaching the cooking sensor.
2. Attach the cooking onto the silicone patch so that it fits perfectly.

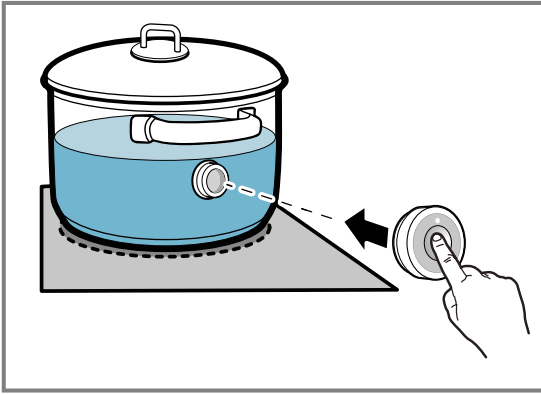

## 15.4 Replacing the battery

If the LED on the wireless cooking sensor does not light up when pressed, the battery is discharged. Changing the battery:

1. Remove the silicone cover from the lower section of the cooking sensor casing and remove both screws using a screwdriver.

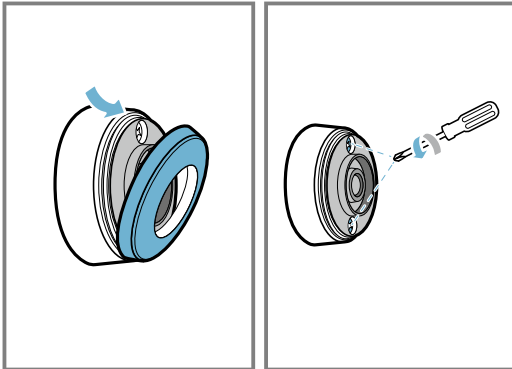

2. Open the cooking sensor lid and remove the battery from the base.

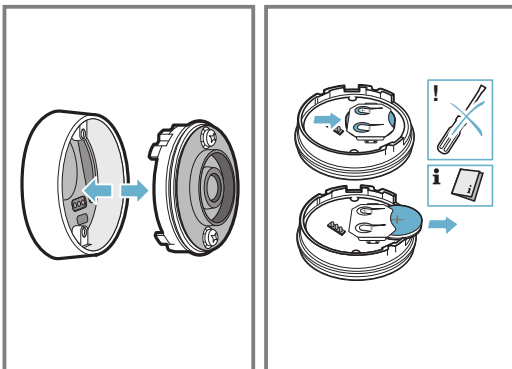

3. Insert a new battery, observing the instructions for the battery poles. Only use premium-quality CR2032 batteries.

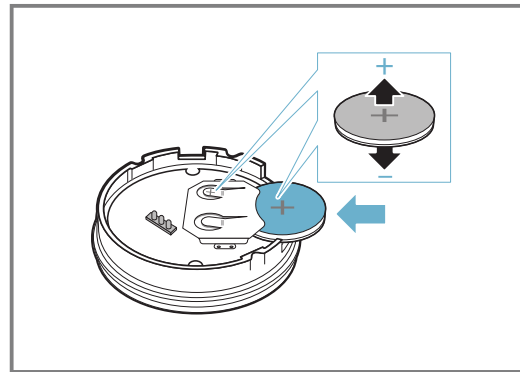

**Note:** Do not use any metal objects to remove the battery. Do not touch the battery connection points.

4. Close the cap on the cooking sensor. The indentations for the screws on the cap must be aligned with the indentations on the lower section of the housing. Use a screwdriver to tighten the screws and secure the silicone cover on the lower section of the cooking sensor housing.

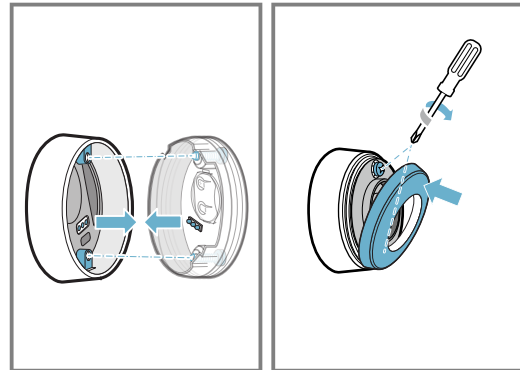

## 15.5 Cleaning

### Cooking sensor

Clean with a damp cloth. Do not place in the dishwasher and do not get it wet.

When you are not using the cooking sensor, remove it from the cookware and store it in a clean, secure location, away from any heat sources.

### Silicone patch

Clean and dry before attaching the cooking sensor. Dishwasher safe.

**Note:** The cookware with the silicone patch must not be left to soak for long periods in soapy water.

### Window for the wireless cooking sensor

Always keep the window clean and dry. Important:

1. Remove dirt and oil splatters regularly.
2. For cleaning, use a cloth or a cotton bud and window-cleaning solution.

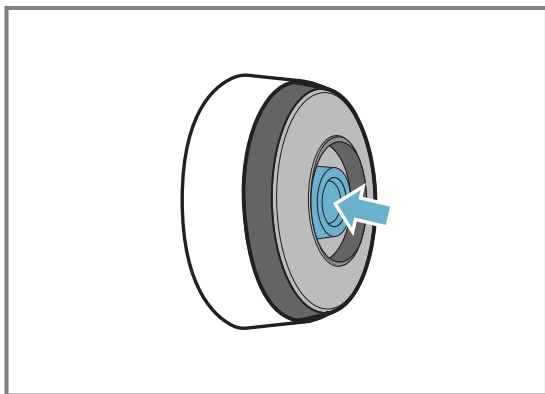

#### Notes

- Do not use hard or rough objects such as bristle brushes or scouring pads to clean the hob, and do not use scouring agents.

- Do not touch the window for the wireless cooking sensor with your fingers; this will soil or scratch it.

## 15.6 Declaration of Conformity

BSH Hausgeräte GmbH hereby declares that the appliance with wireless cooking sensor function meets the basic requirements and other relevant provisions of the Directive 2014/53/EU.

A detailed Declaration of Conformity in accordance with Directive RED can be found at [siemens-home.bsh-group.com](http://siemens-home.bsh-group.com) on the product page for your appliance under "Additional documents".

The logos and the Bluetooth® brand are registered trademarks and property of Bluetooth SIG, Inc. These trademarks are used by BSH Hausgeräte GmbH under licence. All other trademarks and trade names are owned by the respective companies.

## 16 powerMove Pro

This allows you to change the power level during cooking simply by moving the cookware forwards or backwards.

Activating this function will display the preset power levels for the item of cookware. Depending on the position of the cookware, you can select one of the five available power levels: , 3.0, 5.0, 7.0 and 9.0.

You can change the preset power levels in the basic settings.

→ "Basic settings", Page 20

**Note:** If the function does not activate when you select the power level, the appliance may have reached its maximum power consumption. You can find more information about this under Power limitation.

→ "Basic settings", Page 20

### 16.1 Switching on powerMove Pro

- Place the cookware on the cooking surface.
  - Touch  in the main view. You can select the required cooking zone on the screen.
  - Touch the required cooking zone display.
- ✓ The function is switched on.

- Move the cookware over the cooking zone until the power level you require is set. The selected power level is displayed in the cooking zone display.

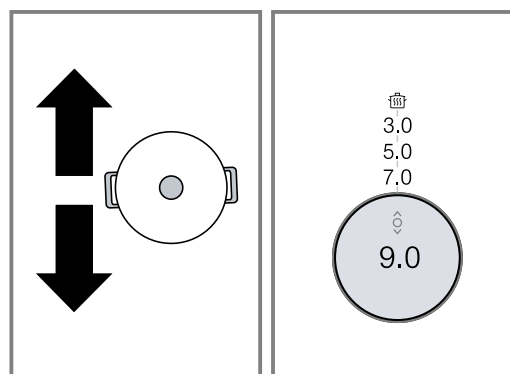

#### Notes

- If the function is not available for the cookware you want to use, an audible signal will sound and the function will not be activated.
- If the function is not available for any of the cookware that is placed,  does not appear on the main display.

### Changing the power level

You can change the power levels while you are cooking. To change to or select a different power level in the programming area, touch the area for which you want to change the power level.

**Note:** If you deactivate the function, the power levels return to the preset values.

### 16.2 Switching off powerMove Pro

- Touch the cooking zone indicator on the main display until the power level 0.0 appears.
- ✓ The cooking zone is switched off.
- ✓ The function is switched off.

## 17 Childproof lock

The hob is equipped with a childproof lock. This prevents children from switching on the hob.

### 17.1 Activating the childproof lock

#### Requirements

- The hob is switched on.
  - All cooking zones are switched off.
1. Open the docking menu.
  2. Touch .
- ✓ The hob is locked.

### 17.2 Switching off Childproof lock

- ▶ Follow the instructions in the display panel.
- ✓ The lock is released.

### 17.3 Automatic childproof lock

You can also activate the childproof lock automatically every time the hob is switched off.

You can find out how to switch the function on and off in the "Basic settings" section → *Page 20*.

## 18 Pause function

The selected settings are retained while the pause function is activated, but no power level is used and the cooking times that have been set will stop. If you have activated the alarm or the timer, it will continue running. You cannot change the alarm time when the pause function is activated. The lock has no effect on the main switch. You can switch off the hob at any time.

### 18.1 Switching on the pause function

- ▶ Press **II**.
- ✓ The hob remains locked for 30 minutes.

- ✓ Now you can clean the surface of the touch display without changing the settings.

### 18.2 Switching off the pause function

- ▶ To switch off the function before the 30 minutes have elapsed, first touch **II** and then confirm on the display.

#### Notes

- If the function does not switch itself off, the hob switches off automatically after 30 minutes.
- If you move the cookware on the cooking surface while the function is activated, all the settings may be lost.

## 19 Individual safety switch-off

The safety function is switched on if one cooking zone is in operation for an extended period and you do not change any settings. A message appears on the display and the cooking zone stops heating.

To switch off the display and reset the cooking zone, touch any button.

## 20 Basic settings

You can configure the basic settings for your appliance to meet your needs.

### 20.1 Overview of the basic settings

Setting	Description and options
Language	Change the display language for the appliance.
Home Connect	You can use this function to connect the appliance to your home network and a mobile device.
cookConnect System	You can use this function to control certain functions of the extractor hood via the hob.
Signal tones	You can use this function to select warning tones that the appliance is to output.

Setting	Description and options
Duration of the warning signal	You can use this function to change the duration of the warning signal.
Signal tone volume	You can use this function to change the volume of the signal tones.
Button tones	You can use this function to select whether the appliance emits tones when you touch the buttons on the touch display.
Display brightness	Change the brightness of the display.
powerMove Plus	You can use this function to change the preset power levels of the three cooking areas of the FlexZone.
Childproof lock	You can use this function to automatically lock the hob to prevent children from using the appliance without supervision.

Setting	Description and options
quickStop function	Allows the cooking zone to be switched off quickly and directly via the main display.
Brand logo	You can use this function to set whether the brand logo is to be displayed when you switch on the hob.
reStart	You can use this function to set how long the appliance saves the most recently used settings when you switch off the appliance.
Power limitation	This enables you to limit the total power of the hob, if required, due to the circumstances of your electrical installation. The available settings depend on the maximum power of the hob. You can find precise information on the rating plate. If the function is switched on and the hob has reached the set power limit, _ is displayed and you cannot select a higher power level.
Cooking sensor	Add a new wireless cooking sensor.

Setting	Description and options
Setting the boiling point	You can enter your height above sea level to improve the cooking sensor's accuracy.
Appliance information	You can use this function to call up information about the appliance.
Factory settings	Reset all settings to the factory settings.

## 20.2 Calling up basic settings

**Requirement:** All cooking zones must be switched off.

1. Open the docking menu.
2. Touch .
3. Drag your finger to scroll through the available settings.
4. To call up the submenu and select the required option, touch a setting.  
To return to the previous menu, touch ← within a submenu.
5. Before you exit the basic settings, save or cancel the settings in the confirmation screen.
6. Touch ← to exit.

# 21 Home Connect

This appliance is network-capable. Connecting your appliance to a mobile device lets you control its functions via the Home Connect app, adjust its basic settings and monitor its operating status.

The Home Connect services are not available in every country. The availability of the Home Connect function depends on the availability of Home Connect services in your country. You can find information about this at: [www.home-connect.com](http://www.home-connect.com).

The Home Connect app guides you through the entire login process. Follow the instructions in the Home Connect app to configure the settings.

**Tip:** Please also follow the instructions in the Home Connect app.

### Notes

- Please note the safety precautions in this instruction manual and make sure that they are also observed when operating the appliance via the Home Connect app.  
→ "Safety", Page 2
- Operating the appliance on the appliance itself always takes priority. During this time it is not possible to operate the appliance using the Home Connect app.
- In networked standby mode, the appliance requires a maximum of 2 W.
- Hobs are not designed to be left unattended. Always monitor the cooking process.

## 21.1 Setting up the Home Connect app

1. Install the Home Connect app on your mobile device.

2. Start the Home Connect app and set up access for Home Connect.  
The Home Connect app guides you through the entire login process.

## 21.2 Setting up Home Connect

### Requirements

- The appliance is connected to the power supply and is switched on.
  - You have a mobile device with a current version of the iOS or Android operating system, e.g. a smartphone.
  - The Home Connect app has been installed on your mobile device.
  - The appliance is receiving signals from the WLAN home network (Wi-Fi) at its installation location.
  - The mobile device and the appliance are within range of your home network's Wi-Fi signal.
1. Open the Home Connect app and scan the following QR code.



2. Follow the instructions in the Home Connect app.

## 21.3 Overview of the Home Connect settings

You can adjust the settings and network settings for Home Connect by going to your hob's basic settings. The hob shows the setting "Set using the assistant" if the hob is not connected to the home network. All other settings are only displayed if the hob is already connected to the Wi-Fi.

Setting	Description and options
Set using the assistant	The hob can be set up to automatically log into your home network, or you can do this manually. <ul style="list-style-type: none"> <li>■ Use the assistant to configure the settings (automatic connection to the home network).<sup>1</sup></li> <li>■ Use the assistant to configure the settings: WPS not supported (manually log into your home network).</li> </ul>
Connect to app	You can connect the hob to one or more Home Connect accounts.
Set using the app	<ul style="list-style-type: none"> <li>■ Off: Only the hob's current status is displayed in the app.</li> <li>■ On<sup>1</sup>: You can send cooking settings from the app to the hob. The cooking settings that are sent must be confirmed on the hob.</li> </ul>
Wi-Fi	You can switch off the hob's wireless module to disconnect it from the Wi-Fi. <ul style="list-style-type: none"> <li>■ Deactivated: The wireless module is switched off.</li> <li>■ Activated<sup>1</sup>: Wireless module connected.</li> </ul>
Disconnecting from the network	You can delete the saved connections to the Wi-Fi. The network connection is also deleted if you restore the factory settings on your hob.
Appliance info	You can display information about Home Connect and the network.

<sup>1</sup> Factory setting

## 21.4 Wi-Fi symbol

The Wi-Fi indicator on the main screen changes according to the status and quality of the connection and the availability of the Home Connect server. If you press and hold the symbol for at least two seconds, the display shows a description of the symbol.

## 21.5 Changing settings via the Home Connect app

You can use the Home Connect app to change the settings for the cooking zones and send them to the hob.

### Requirements

- The hob is connected to the Wi-Fi and to the Home Connect app.
  - In order to set the hob via the Home Connect app, the basic setting "Setting via the app" must be switched on. The basic setting is switched on on delivery. If the option for the transmission of settings has been deactivated, only the hob's operating statuses will be displayed in the Home Connect app.
1. Select the setting in the Home Connect app and send it to the hob. Follow the instructions in the Home Connect app. Settings that you send from the Home Connect app to the hob must be confirmed on the hob.
    - ✓ If cooking settings are transmitted to a cooking zone, the display shows a message.
  2. To confirm a setting, touch "Apply".
  3. To discard the setting, touch "Discard".

## 21.6 Software update

Your appliance's software can be updated using the software update function, e.g. for the purposes of optimisation, troubleshooting or security updates. To do this, you must be a registered Home Connect user, have installed the app on your mobile device and be connected to the Home Connect server. As soon as a software update is available, you will be informed via the Home Connect app and will be able to start the software update via the app. Once the update has been successfully downloaded, you can start installing it via the Home Connect app if you are in your home network (Wi-Fi). The Home Connect app informs you once installation is successful.

### Notes

- The software update consists of two steps.
  - The first step is the download.
  - The second step is the installation on your appliance.
- You can continue to use your appliance as normal while updates are downloading. Depending on your personal settings in the app, software updates can also be set to download automatically.
- Installation takes a few minutes. You cannot use your appliance during installation.
- We recommend that you install security updates as soon as possible.

## 21.7 Remote diagnostics

Customer Service can use Remote Diagnostics to access your appliance if you contact them, have your appliance connected to the Home Connect server and if Remote Diagnostics is available in the country in which you are using the appliance.

**Tip:** For further information and details about the availability of Remote Diagnostics in your country, please visit the service/support section of your local website: [www.home-connect.com](http://www.home-connect.com).

## 21.8 Data protection

Please see the information on data protection.

The first time your appliance is registered on a home network connected to the Internet, your appliance will transmit the following types of data to the Home Connect server (initial registration):

- Unique appliance identification (consisting of appliance codes as well as the MAC address of the installed Wi-Fi communication module).
- Security certificate of the Wi-Fi communication module (to ensure a secure data connection).

- The current software and hardware version of your appliance.
- Status of any previous resetting to factory settings.

This initial registration prepares the Home Connect functions for use and is only required when you want to use the Home Connect functions for the first time.

**Note:** Please note that the Home Connect functions can only be utilised with the Home Connect app. Information on data protection can be retrieved in the Home Connect app.

## 22 Hob-based hood control

If the hob and the extractor hood are Home Connect-compatible, connect the appliances in the Home Connect app. To do this, connect the two appliances to Home Connect and follow the instructions in the app.

### Notes

- Using the controls on the extractor hood always takes priority. It is not possible to use the hob-based hood control during this time.
- You can only connect to the extractor hood via the Home Connect app. Other connection routes are no longer supported.

### 22.1 Resetting Home Connect settings

If you have problems connecting your appliance to the WLAN home network (Wi-Fi) or if you want to log your appliance onto a different WLAN home network (Wi-Fi), you can reset the Home Connect settings.

**Note:** If you reset the Home Connect settings, the connection to any extractor hood will also be terminated.

1. Touch  to open the basic settings.
2. Select the "cookConnect hood control" setting.
3. Touch "Disconnect".

### 22.2 Controlling the extractor hood via the hob

In the basic settings for your hob, you can adjust the behaviour of your extractor hood depending on whether the hob or individual cooking zones are switched on or off.

### 22.3 Overview of the hood control settings

In the basic settings for your hob, you can adjust the behaviour of your extractor hood depending on whether the hob or individual cooking zones are switched on or off.

The display shows the settings only when the appliance has been connected to the extractor hood.

You can select other settings using the controls on the hob.

#### Setting the fan

1. Touch  on the control panel.
  - ✓ The display shows the preset fan setting.
2. Select a fan setting.
  - You can choose between the levels 1, 2 and 3.
  - To set an intensive setting, touch **int 1** or **int 2**.

#### Switching off the fan

1. Touch  on the control panel.
2. Select fan setting 0.

#### Switching on automatic mode

1. Touch  on the control panel.
2. Select auto.
  - ✓ The fan starts automatically when steam is produced.

#### Switching off automatic mode

1. Touch  on the control panel.
2. Select fan setting 0.

#### Setting the hood lighting

You can switch the hood lighting on and off using the control panel of the hob.

- ▶ To switch on the lighting, touch  in the main screen.

Setting <sup>1</sup>	Selection	Description
Fan control (automatic start)	<ul style="list-style-type: none"> <li>▪ Switched off – The extractor hood must be switched on manually, if required.</li> <li>▪ Switched on in automatic mode<sup>2</sup> – In automatic mode, the hood switches itself on when you switch on any of the cooking zones.</li> <li>▪ Switched on in standard mode – The extractor hood is switched on at a specified setting when a cooking zone is switched on.</li> </ul>	You can set whether/how the fan starts when you switch on the hob.
Fan run-on	<ul style="list-style-type: none"> <li>▪ Fan off.</li> <li>▪ Switched on in automatic mode.<sup>2</sup></li> <li>▪ Switched on with standard fan run-on.</li> <li>▪ The fan settings cannot be adjusted when the hob is switched off.</li> </ul>	You can set whether/how the fan continues to run when you switch off the hob.
Automatic light activation	<ul style="list-style-type: none"> <li>▪ Off</li> <li>▪ On<sup>2</sup> – The light is switched on when the hob is switched on.</li> </ul>	You can set whether the lighting for the extractor hood switches on automatically with the hob.
Automatic light deactivation	<ul style="list-style-type: none"> <li>▪ Off<sup>2</sup></li> <li>▪ On – The light switches itself off when the hob is switched off.</li> </ul>	You can set whether the lighting for the extractor hood switches off automatically with the hob.
Disconnect	-	With this setting, you reset the saved connections to the Wi-Fi or go back to the extractor hood.

<sup>1</sup> Depending on the appliance specifications

<sup>2</sup> Factory setting (may vary according to model)

## 23 Cleaning and servicing

To keep your appliance working efficiently for a long time, it is important to clean and maintain it carefully.

### 23.1 Cleaning products

You can obtain suitable cleaning products and glass scrapers from customer service, a retailer or the online shop [siemens-home.bsh-group.com](http://siemens-home.bsh-group.com).

#### ATTENTION!

Unsuitable cleaning products may damage the surfaces of the appliance.

- ▶ Never use unsuitable cleaning products.
- ▶ Do not use cleaning products while the hob is still hot. This may cause marks on the surface.

#### Unsuitable cleaning products

- Undiluted detergent
- Detergent intended for dishwashers
- Abrasive cleaning products
- Aggressive cleaning products such as oven spray or stain remover
- Abrasive sponges
- High-pressure or steam jet cleaners

### 23.2 Cleaning the hob

Clean the hob after every use to stop cooking residues from getting burnt on.

**Requirement:** The hob must be cold. Do not allow the hob to cool down if it has sugar stains, rice starch, plastic or aluminium foil on it.

1. Remove heavy soiling using a glass scraper.
2. Clean the hob with a cleaning agent for glass ceramic.

Follow the cleaning instructions on the packaging of the cleaning agent.

#### Tips

- You can achieve good cleaning results using a special sponge for glass ceramic.
- If you keep the base of the cookware clean, the hob surface remains in a good condition.

### 23.3 Cleaning the hob surround

If the hob frame is dirty or stained after use, clean this.

**Note:** Do not use a glass scraper.

1. Clean the hob frame with hot soapy water and a soft cloth.  
Wash new sponge cloths thoroughly before use.
2. Dry with a soft cloth.



## 24 Troubleshooting

You can rectify minor faults on your appliance yourself. Read the troubleshooting information before contacting after-sales service. This will avoid unnecessary costs.

### **⚠ WARNING – Risk of injury!**

Improper repairs are dangerous.

- ▶ Repairs to the appliance should only be carried out by trained specialist staff.
- ▶ If the appliance is defective, call Customer Service. → "Customer Service", Page 28

### **⚠ WARNING – Risk of electric shock!**

Improper repairs are dangerous.

- ▶ Repairs to the appliance should only be carried out by trained specialist staff.
- ▶ Only use genuine spare parts when repairing the appliance.
- ▶ If the power cord or the appliance power cable of this appliance is damaged, it must be replaced with a special power cord or special appliance power cable, which is available from the manufacturer or its Customer Service.

### 24.1 Warnings

If a problem occurs, instructions, warnings or error messages are shown automatically on the display. To eliminate the problem, follow the instructions on the touch display. If required, contact customer service and specify the exact fault code.

#### Notes

- If an error occurs, the appliance does not switch to standby mode.
- In order to protect the appliance's electronic parts from overheating or surge currents, the hob may temporarily reduce the power level.

### 24.2 Information on the display panel

Fault	Cause and troubleshooting
The hob cannot be switched on.	<p>The power supply has been disconnected.</p> <ul style="list-style-type: none"> <li>▶ Use other electrical appliances to check whether there has been a power failure.</li> </ul> <p>The appliance has not been connected as shown in the circuit diagram.</p> <ul style="list-style-type: none"> <li>▶ Connect the appliance in accordance with the circuit diagram.</li> </ul> <p>Electronics fault</p> <ul style="list-style-type: none"> <li>▶ If you are unable to rectify the fault, inform the technical after-sales service.</li> </ul>
The touchscreen display is not responding or has frozen.	<p>The control panel is wet or an object is covering it.</p> <ul style="list-style-type: none"> <li>▶ Dry the control panel or remove the object.</li> </ul>
The cooking zone's power level cannot be increased.	<p>The hob's total power output has been limited.</p> <ul style="list-style-type: none"> <li>▶ Change the total power under "Maximum power consumption" in the basic settings.</li> <li>▶ If a very large item of cookware is being used, this may have an effect on the maximum power level for that half of the hob. Place the cookware back on the hob.</li> </ul>
Audible signal	<p>There is something on the touch display.</p> <ol style="list-style-type: none"> <li>1. Remove the object and reconfigure the hob settings.</li> <li>2. Do not place hot cookware on the control panel.</li> </ol>
The hob is responding in an unusual manner or can no longer be operated correctly.	<p>A fault has occurred in the electronics.</p> <ol style="list-style-type: none"> <li>1. Switch off the appliance using the mains fuse or the circuit breaker in the fuse box.</li> <li>2. Wait a few seconds before reconnecting the appliance.</li> </ol>
One or all cooking zones have been automatically switched off.	<p>The electronics have overheated and one or all of the cooking zones have been switched off.</p> <p>There is hot cookware in the vicinity of the control panel. The cooking zone has been switched off to protect the electronics.</p> <p>The cooking zone has overheated and has been switched off to protect the work surface.</p>
The transfer settings function cannot be activated.	<p>Electronics fault</p> <ul style="list-style-type: none"> <li>▶ Touch any button to confirm the fault display. You can continue to cook as normal without using the flexMotion function. Contact customer service.</li> </ul>

<b>Fault</b>	<b>Cause and troubleshooting</b>
<i>E7010</i>	The hob is unable to connect to your home network or the extractor hood. <ol style="list-style-type: none"> <li>1. Acknowledge the fault display by touching any of the sensor fields. You can cook as usual without a connection.</li> <li>2. If the problem persists, contact our technical after-sales service.</li> </ol>
<i>E8202</i>	The cooking sensor has overheated and the cooking zone has been switched off. <ul style="list-style-type: none"> <li>▶ Wait until the cooking sensor has cooled down sufficiently before activating the function again.</li> </ul>
<i>E8203</i>	The cooking sensor has overheated and all of the cooking zones have been switched off. <ul style="list-style-type: none"> <li>▶ When you are not using the cooking sensor, remove it from the cookware and keep it away from other cooking zones or heat sources. Switch on the cooking zones.</li> </ul>
<i>E8204</i>	The battery in the cooking sensor is almost flat. The next time you cook, you may be interrupted by the battery running out. <ul style="list-style-type: none"> <li>▶ Replace the 3 V CR2032 battery. For more information, see the section entitled → <i>"Replacing the battery", Page 18</i></li> </ul>
<i>E8205</i>	The connection to the cooking sensor has been broken. <ul style="list-style-type: none"> <li>▶ Switch off the function and reactivate it.</li> </ul>
<i>E8206</i>	The cooking sensor is broken/faulty. <ul style="list-style-type: none"> <li>▶ Contact the technical after-sales service.</li> </ul>
The wireless cooking sensor display does not light up.	The wireless cooking sensor is not responding and the display does not light up. <ul style="list-style-type: none"> <li>▶ Replace the 3 V CR2032 battery. For more information, see the section entitled → <i>"Replacing the battery", Page 18</i>.</li> <li>▶ If this does not solve the problem, press and hold the symbol on the cooking sensor for 8–10 seconds and then reconnect the cooking sensor to the hob. You can find more information in the section entitled → <i>"Connecting the wireless cooking sensor", Page 16</i>.</li> <li>▶ If the problem persists, contact our technical after-sales service.</li> </ul>
The display on the sensor flashes twice.	The battery in the cooking sensor is almost flat. The next time you cook, you may be interrupted by the battery running out. <ul style="list-style-type: none"> <li>▶ Replace the 3 V CR2032 battery. For more information, see the section entitled → <i>"Replacing the battery", Page 18</i>.</li> </ul>
The display on the sensor flashes three times.	The connection to the cooking sensor has been broken. <ul style="list-style-type: none"> <li>▶ Press and hold the symbol on the cooking sensor for 8–10 seconds and then reconnect the cooking sensor to the hob.</li> </ul>
<i>E 9000/E9010</i>	The operating voltage is incorrect and outside of the normal operating range. <ul style="list-style-type: none"> <li>▶ Contact your energy supplier.</li> </ul>
<i>U400/E9011</i>	The hob is not connected correctly. <ul style="list-style-type: none"> <li>▶ Disconnect the hob from the mains. Connect the hob in accordance with the circuit diagram.</li> </ul>
The cooking zones do not heat up, and <small>DEMO MODE</small> is displayed.	Demo mode is activated. <ol style="list-style-type: none"> <li>1. Disconnect the hob from the mains and, after a few seconds, reconnect it.</li> <li>2. Deactivate demo mode in the basic settings within the next three minutes.</li> </ol>

### 24.3 Normal noises from your appliance

An induction hob may sometimes cause noises or vibrations, such as buzzing, crackling, hissing noises, fan noises or rhythmic noises.

## 25 Disposal

### 25.1 Disposing of old appliance

Valuable raw materials can be reused by recycling.

1. Unplug the appliance from the mains.
2. Cut through the power cord.
3. Dispose of the appliance in an environmentally friendly manner.

Information about current disposal methods are available from your specialist dealer or local authority.



This appliance is labelled in accordance with European Directive 2012/19/EU concerning used electrical and electronic appliances (waste electrical and electronic equipment - WEEE).

The guideline determines the framework for the return and recycling of used appliances as applicable throughout the EU.

## 25.2 Disposing of batteries

Batteries should be recycled in an environmentally friendly manner. Do not dispose of the batteries in the household rubbish.

- ▶ Dispose of batteries in an environmentally friendly manner.



According to the European Guideline 2006/66/EC, defective or used battery packs/batteries, must be collected separately and disposed of in an environmentally correct manner.

## 26 Declaration of Conformity

BSH Hausgeräte GmbH hereby declares that the appliance with Home Connect functionality conforms to the basic requirements and other relevant provisions of Directive 2014/53/EU.

A detailed RED Declaration of Conformity can be found online at [siemens-home.bsh-group.com](http://siemens-home.bsh-group.com) among the additional documents on the product page for your appliance.



Hereby, BSH Hausgeräte GmbH declares that the appliance with Home Connect functionality is in compliance with relevant statutory requirements.<sup>1</sup>

A detailed Declaration of Conformity can be found online at [siemens-home.bsh-group.com/uk/](http://siemens-home.bsh-group.com/uk/) among the additional documents on the product page for your appliance.<sup>1</sup>



2.4 GHz band (2400–2483.5 MHz): Max. 100 mW  
5-GHz band (5150–5350 MHz + 5470–5725 MHz):  
max. 50 mW



BE	BG	CZ	DK	DE	EE	IE	EL	ES
FR	HR	IT	CY	LI	LV	LT	LU	HU
MT	NL	AT	PL	PT	RO	SI	SK	FI
SE	NO	CH	TR	IS	UK (NI)			

5 GHz WLAN (Wi-Fi): For indoor use only.

AL	BA	MD	ME	MK	RS	UK	UA
----	----	----	----	----	----	----	----

5 GHz WLAN (Wi-Fi): For indoor use only.

### 26.1 Statement of Compliance for Great Britain

#### Product type

This statement of compliance covers the products described in this information for use whose model identifier group is seen on the title page. The full model identifier is made up of the characters before the slash in the product number (E no.) which can be found on the rating plate. Alternatively, you can also find the model identifier in the first line of the UK Energy Label.

#### Name and address of manufacturer

BSH Hausgeräte GmbH, Carl-Wery-Strasse 34, 81739 München, Germany

This statement of compliance is prepared by the manufacturer.

The manufacturer, BSH Hausgeräte GmbH deems that it has complied with

- provision 5.1-1 of ETSI EN 303 645 v2.1.1 and, where relevant, provision 5.1-2 of ETSI EN 303 645 v2.1.1;
- provision 5.2-1 of ETSI EN 303 645 v2.1.1;
- provision 5.3-13 of ETSI EN 303 645 v2.1.1.

#### Support period

BSH Hausgeräte GmbH will provide security updates that are necessary to maintain the main functions free of charge until at least 28/02/2034.

<sup>1</sup> Only applies to Great Britain

## 27 Customer Service

Function-relevant genuine spare parts according to the corresponding Ecodesign Order can be obtained from Customer Service for a period of at least 10 years from the date on which your appliance was placed on the market within the European Economic Area.

**Note:** Under the terms of the manufacturer's warranty the use of Customer Service is free of charge.

Detailed information on the warranty period and terms of warranty in your country is available from our after-sales service, your retailer or on our website.

If you contact Customer Service, you will require the product number (E-Nr.) and the production number (FD) of your appliance.

The contact details for Customer Service can be found in the enclosed Customer Service directory or on our website.

### 27.1 Product number (E-Nr.) and production number (FD)

You can find the product number (E-Nr.) and the production number (FD) on the appliance's rating plate.

The rating plate can be found:

- on the appliance certificate.
- on the lower section of the hob.

The product number (E no.) can also be found on the glass ceramic. You can also display the customer service index (KI) and the production number (FD) in the basic settings. → *Page 20*

Make a note of your appliance's details and the Customer Service telephone number to find them again quickly.







EN Manufactured by BSH Hausgeräte GmbH under the trademark licence of Siemens AG

Valid within Great Britain:  
Imported to Great Britain by  
BSH Home Appliances Ltd.  
Grand Union House  
Old Wolverton Road  
Wolverton, Milton Keynes  
MK12 5PT  
United Kingdom

**BSH Hausgeräte GmbH**  
Carl-Wery-Straße 34  
81739 München, GERMANY  
[siemens-home.bsh-group.com](http://siemens-home.bsh-group.com)



9001725855

(040412)

en